

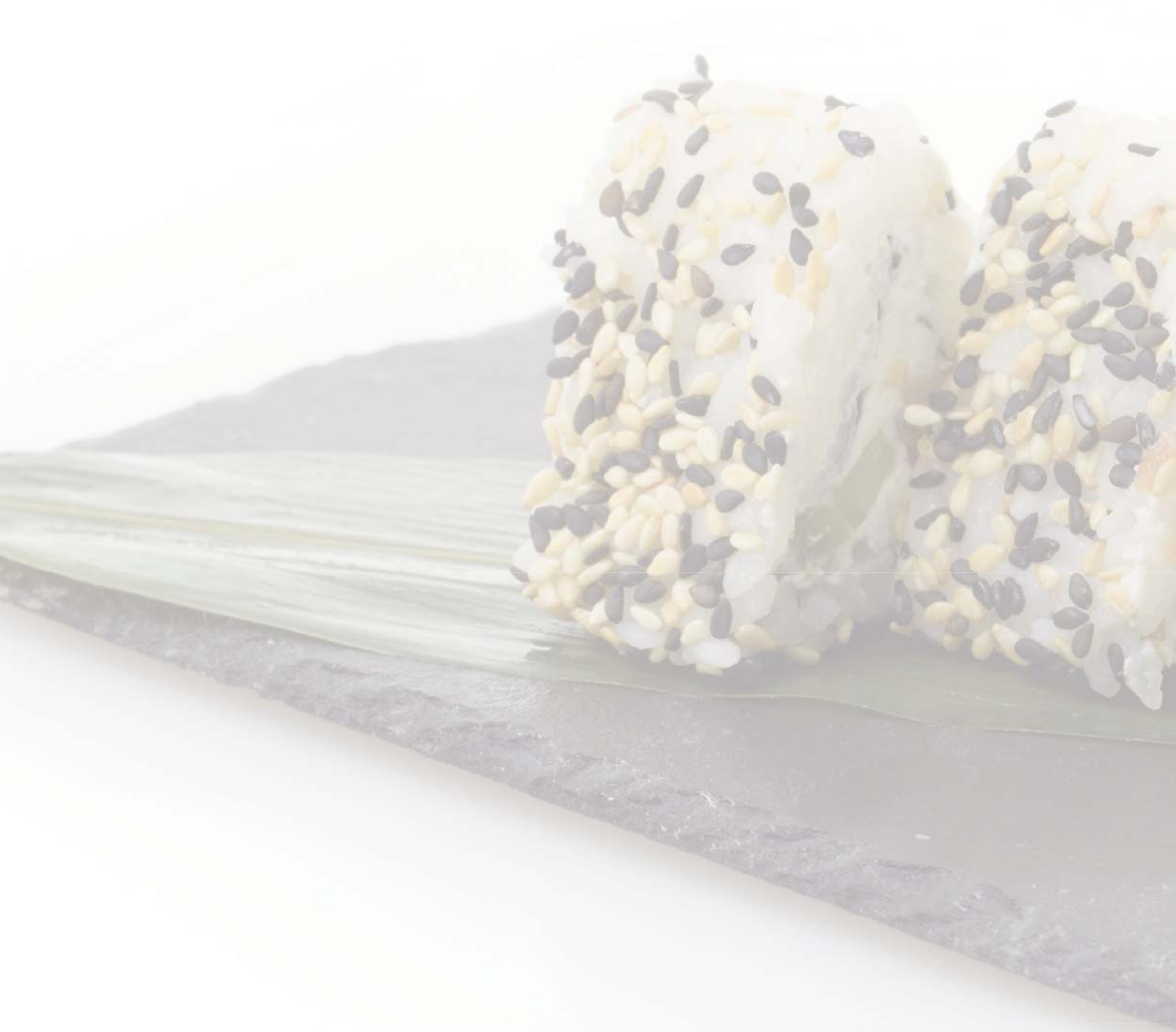

PENTAVALENT BLAST CHILLER

EN USE AND MAINTENANCE MANUAL



The manufacturer cannot be held liable for unintended device use. Original document language: Italian. The manufacturer is not liable for any transcription or translation errors. IT IS forbidden to reproduce this manual, even partially.

Congratulations on having purchased our equipment!

Work is simpler due to the intuitive user interface graphics, designed to simplify function access, that are displayed to be immediately identified and promote user and device interaction. A concentration of technology in a single machine that allows you to perform different and complementary activities for the best efficiency in the kitchen: this way you'll be immediately operative, without having to run any complex procedures also thanks to the 300 processes and cycles.

This manual furnishes all necessary information necessary for correct device use and appropriate maintenance.

Read the instructions carefully before any operation, as they provide essential indications concerning the device safety state.



USER PART

SAFETY INSTRUCTIONS FOR USE	5
LEARNING ABOUT THE DEVICE	7
Correctly loading the equipment	9
Achieving better results and working in safe conditions.....	10
How to use the needle probe	10
Rack adjustment for GASTRONORM or 600X400 trays	11
USE	
Turning on and off.....	12
Keyboard lock and unlock.....	12
Initial settings.....	13
Language settings.....	13
Date and time settings.....	13
POSITIVE CHILLING +3°C	
Positive Chilling with saved recipe (Cookbook)	14
Editing saved recipes (Cookbook) and creating a personal recipe (My recipes).....	15
Positive Chilling with automatic or manual cycles.....	17
Positive Storage	18
Saving the completed Positive Chilling cycle.....	19
Default values for automatic or manual Positive Chilling cycles (+3°C)	20
NEGATIVE CHILLING -18°C	
Negative Chilling with saved recipe (Cookbook)	23
Editing saved recipes (Cookbook) and creating a personal recipe (My recipes).....	24
Negative Chilling with automatic or manual cycles.....	26
Negative Storage	27
Anisakis killer	27
Saving the completed Negative Chilling cycle.....	28
Default values for automatic or manual Negative Chilling cycles (-18°C)	29
THAWING	
Editing thawing cycle parameters (optional)	33
AUTOMATIC LEAVENING RETARDER	
Automatic leavening retarder.....	35
Default values for Leavening Retarder cycles.....	37
Editing Leavening Retarder cycle parameters (optional)	38
Manual Leavening Retarder.....	39
Manual Rising	42
SLOW COOKING	
Cooking only	43
Manual mode (with parameters to be set)	43
Automatic mode (using saved recipes).....	44
Cooking + Chilling.....	46
SPECIAL FUNCTIONS	
Cookbook	48
My recipes (saving custom recipes)	49
Creating a recipe.....	49
Needle Probe Heating	50
Sterilox (optional)	50
Hot gas defrost	51
Pre-cooling	51
Drying	52
Continuous Cycle	52
USB Menu.....	54
SERVICE FUNCTIONS	
Set Point	55
Parameters	60
MAINTENANCE	
Routine cleaning.....	64
Disuse	65
Customer service.....	66
ALARMS	67
Disposal at end working life	69
Warranty.....	69



SAFETY INSTRUCTIONS FOR USE

- Use and cleaning other than those indicated and foreseen in this booklet are considered improper and can cause damages, injuries or fatal accidents, null and void the warranty and hold the manufacturer harmless from any liability.
- Use is solely reserved to appropriate and trained personnel who attend periodic refresher courses.
- Children should not play with or use the equipment. Cleaning and maintenance to be performed by the user should not be performed by children.
- Keep away from electrical parts with wet hands or bare feet.
- Tampering with or removing adopted safety devices IS strictly prohibited (protection grates, hazard stickers, etc.). The manufacturer cannot be held liable if these instructions are not heeded.
- Do not insert screwdrivers or other objects between guards (fan guards, evaporator guards, etc.).
- For good compressor and evaporator unit operations, never obstruct the air vents.
- In the event of fire, do not use water. Install a CO₂ (carbon dioxide) extinguisher and cool the motor compartment as quickly as possible.

CORRECT EQUIPMENT USE

- This equipment is considered an agri-food machine (EC Regulation no. 1935/2004), intended to process food products in industrial and professional kitchens. It is not suited to store pharmaceutical, chemical or any other non-food product.
- Specifically:
 - Display cabinets (+2/+8°C): suited to store and display bottles, tins, etc.
 - Refrigerators (-2/+8°C): suited to store fresh and packaged pre-cooked foodstuffs as well as beverages for short periods of time.
 - Freezers (-22/-15°C): suited to store frozen products for long periods of time
 - Blast chillers (+90/+3°C) (+90/-18°C): suited to rapidly lower food temperature to keep organoleptic properties unaltered
 - Leavening retarders (-15/+40°C) (-2/+40°C): suited to process and store dough.
- The following instructions must be followed for best equipment performance:
 - Do not place hot food (except for chiller functions), uncovered liquids, live animals, various objects or corrosive products in the equipment.
 - Package or otherwise protect food especially if they contain aromas or spices.
 - Arrange foodstuffs inside the equipment to avoid limiting air circulation, avoiding placing paper, cardboard, cutting boards, etc- that can hinder air passage on the racks.
 - Avoid frequent and prolonged door opening as much as possible.
 - If the door was opened, wait a few seconds before re-opening it.
 - Gradually arrange food starting from the bottom up; vice versa, remove food starting from the top down. The maximum load (evenly distributed) per tray or rack is 40 kg.
- Refrigerator equipment was constructed and designed with suitable details to guarantee user health and safety and does not have hazardous corners, shape surfaces or protruding elements. There stability is also guaranteed with doors opened however, hanging on doors is prohibited.
- Failure to follow these instructions could cause damages and injuries, even fatal, and null and voids the warranty.

IN THE EVENT OF EQUIPMENT MALFUNCTIONS...

- If the equipment does not work or functional or structural alterations are noted, disconnect it from the power and water mains and contact a service centre authorised by the manufacturer without attempting to repair it on your own. Original spare parts are recommended. The manufacturer may not be held liable for the use of non original spare parts.
- To ensure that the device is in perfect use and safety conditions, we recommend you have it maintained and serviced by an authorised service centre at least once a year.



RISKS ASSOCIATED WITH EQUIPMENT USE

- RISKS DUE TO MOVEMENTS ON WHEELS: if the equipment is installed on wheels, be careful, during movements, not be violently push the equipment to prevent it from overturning and damaging, also be careful of any roughness on the sliding surface. Equipment with wheels cannot be levelled, thus make sure the support surface is perfectly horizontal and flat. Always lock the wheels with the specific stops.
- RISKS DUE TO MOBILE ELEMENTS: the only mobile element is the fan but does not constitute any risk since it is protected by a protection grate secured with screws.
- RISKS DUE TO LOW/HIGH TEMPERATURES: stickers marked "TEMPERATURE HAZARD" were affixed near areas with low/high temperature risks.
- RISKS DUE TO ELECTRICITY: risks of electrical nature were resolved by designing electrical systems as per regulations CEI EN 60204-1 and CEI EN 60335-1. Specific stickers marked "high voltage" identify areas with electrical hazards.



page 14
Positive Chilling

- It rapidly brings the product core temperature to +3°C, reduces natural product evaporation maintaining its humidity and preventing bacterial proliferation after cooking.
- The positive chilling function lets you plan dishes in advance, increase productivity, keep flavour, colour, fragrance and weight unaltered and eliminate the risk of intoxication and waste.
- All the organoleptic properties are kept intact due to perfect air and temperature control in the chamber.

page 23
Negative Chilling

- It rapidly brings the product core temperature to -18°C, keeping product structure and consistency intact.
- Negative Chilling allows you to purchase products at their peak of freshness, maturity and availability on the market and preserve all their properties intact.
- Thanks to a -40°C controlled air flow, the qualities of a fresh product can be preserved in time.

page 32
Thawing

- To control and determine product thawing means keeping the organoleptic properties intact and optimising stock, avoiding useless waste.
- Thawing occurs in maximum food safety conditions, by the slow re-absorption of the micro-crystallised water in food.
- The ideal cycle for products to be served raw or cold, like fish or pastry products, since it does not damage the molecular structure.

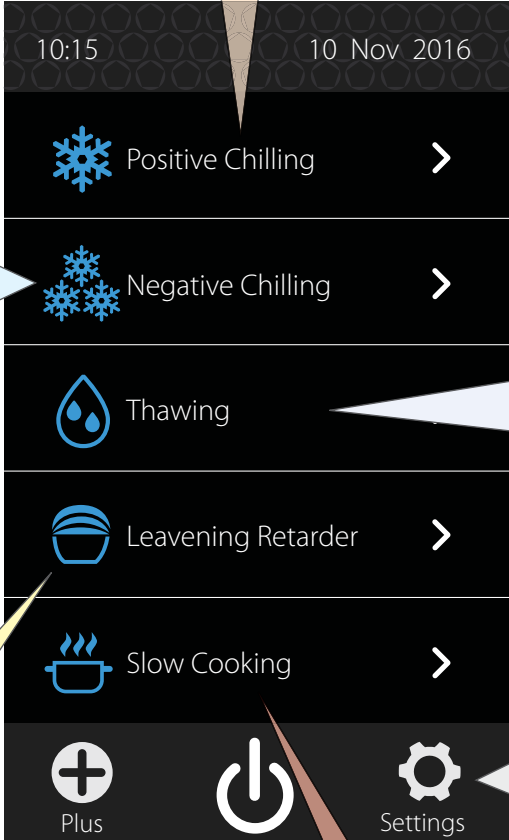

page 34
Leavening Retarder

- "Just in time" production flexibility is the best way to optimise resources, manage time and meet demand variability.
- Direct or programmed leavening can be selected: you prepare, leave to rise, block leavening and decide baking phase programming.
- All this will have an accurate control of humidity to always achieve perfect results.

page 13
Settings

page 48
Special functions

- Needle Probe Heating
- Sterilox
- Defrost
- Pre-cooling
- Drying
- Continuous Cycle

page 43
Slow Cooking

- Temperature control and keeping it within set values allows for preparations that safeguard not only the flavour and taste, but moistness and softness for extremely satisfying results.
- This function is very easy to use and perfect to keep food warm during service, helping to improve preparation and organisation.
- This cycle can also be used in baking to melt chocolate or candied fruit.

What does a blast chiller do?

A blast chiller is a device that quickly lowers the temperature of the introduced food, whether fresh or cooked. Fresh or just cooked food has the maximum organoleptic qualities and flavour; however, if not eaten immediately, it loses the initial quality properties in time and micro-organisms, potential harmful to man, multiply.

Positive Chilling is used when food is not eaten immediately after its preparation, reducing the product temperature to +3°C at the core within 90 minutes. Subsequently, the product must be stored in a refrigerator at a temperature between 0/+3°C where it can be kept for up to 5 days.

Negative Chilling is used to keep all organoleptic characteristics intact. The chiller reduces the product temperature to reach -18° C at its core. Subsequently, the product must be stored in a freezer at a constant temperature of -20 degrees and can even be eaten after 3-12 months, according to the product, provided the cold chain regulations are met.

Normal refrigerators and freezers, unlike a blast chiller, do not have the ability to quickly lower the initial product temperature, consequently, the latter is damaged on the organoleptic and flavour levels.

Why controlled thawing?

With the **Thawing** function, this device returns frozen products to a positive temperature in a controlled and fast manner, meeting HACCP standards: this means always remaining under temperatures where bacterial flora exponentially reproduce.

Furthermore, cooking a thawed product in a controlled manner is better than cooking a cooked product from an initial frozen condition since it reduces the risk of having not fully cooked parts.

What does a Leavening Retarder do?

Controlled leavening is used for bread and pastry doughs by managing temperature, humidity and time. This improves product quality and eliminates baker night shifts: dough is prepared during the day and, once ready, placed in the equipment and, through programming, leavening is blocked until the time when you want the bread ready to be baked.

Why use the Slow Cooking function?

The first experiments with low temperature cooking date back almost two centuries ago by Benjamin Thompson (1753-1814), a brilliant British physicist of American origin.

The scientist, with practical experiments, realised that meat cooked at low temperatures for very long periods of time lost less weight than those cooked otherwise, keeping them softer, redder and tastier.

Benjamin Thompson realised, two centuries ago, that we now know for certain: slow cooking enhances the quality of the ingredients without eliminating their flavourful juices, keeping the vitamin content higher while dissolving the connective tissue, the ones that make meat chewy.



Correctly loading the equipment

Food should be placed in a single layer in containers:

- uncovered;
- food-safe;
- resistant to the temperatures reached by chilling and slow cooking cycles;
- with low edges (maximum 4.5 cm).

Containers should be evenly placed inside the cell.

Correct container placement will permit free air circulation in the cell: avoid obstructing the air vents and overloading the equipment over the admissible limits.

Model			051	081	121	161	122
Chiller capacity in 90'	+90>+3°C	kg	18	25	36	55	72
Freezing capacity in 240'	+90>-18°C	kg	12	16	24	36	48
Guide position	max	no.	18	36	49	68	49
Types of trays/racks			GN1/1 600x400	GN1/1 600x400	GN1/1 600x400	GN1/1 600x400	GN2/1 600x800
Tray capacity	45 mm step	no.	6	12	17	23	17
	60 mm step	no.	5	9	12	17	12
	75 mm step	no.	4	7	10	14	10

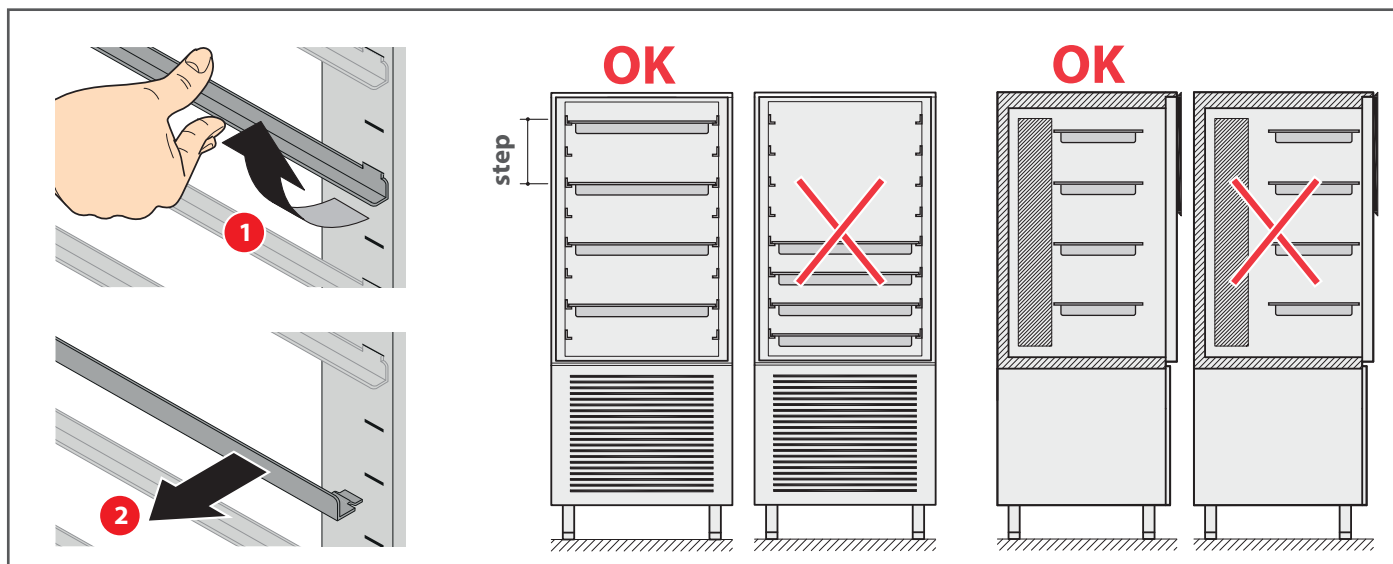
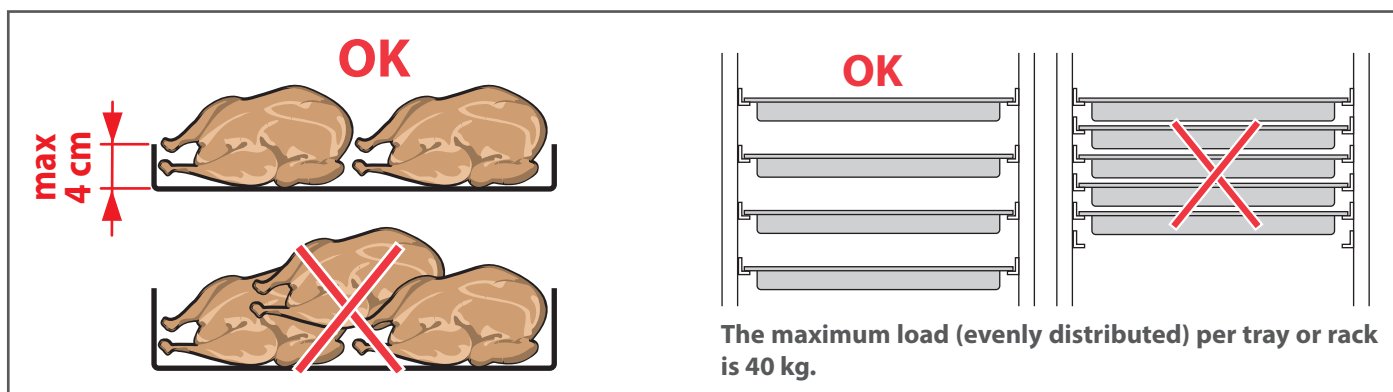

Achieving better results and working in safe conditions

- Keep the motor compartment air vents free of objects and remove dust;
- periodically clean and replace the filter behind the motor compartment air vents:



For further information on how to remove the filter, see chapter Vent cleaning on page 65.

- arrange food to be chilled or cooked as explained in the previous chapter;
- accurately close the doors during each work cycle;
- always keep the defrost water drain hole free;
- avoid opening doors during positive/negative chilling or slow cooking cycles;
- perform routine maintenance as indicated in the specific section;



For further information on how to remove the filter, see paragraph MAINTENANCE on page 64.

- when cooking racks of particularly fatty food (for example, chicken), insert a tray on the bottom of the chamber to collect fat that may drip from food;
- do not use easily flammable foods or liquids (e.g. alcohol) when cooling.

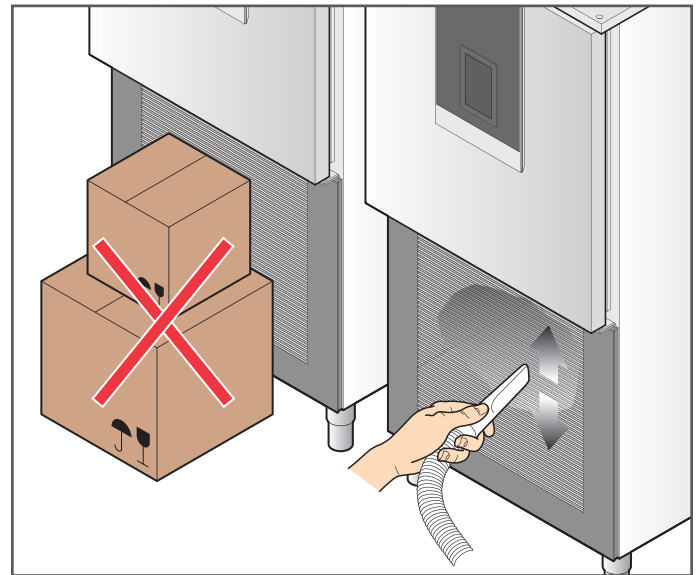

How to use the needle probe

The needle probe, during chilling or cooking, reads the temperature at the food "core": when it reaches the value set by the user or default value, it means the food is chilled (**Chilling**) function, or cooked (**Slow Cooking**) function.

The needle probe is fully inserted in the food to be chilled/cooked: make sure its tip reaches the food "core", meaning the most internal point, without exiting.

Be careful not to insert it in very fatty points and near bones. If food is too thin, insert the probe parallel to the support surface. Always keep the probe clean and sanitised.



HANDLE THE PROBE WITH CARE SINCE IT IS SHARP AND, WHEN USED WHEN COOKING, REACHES HIGH TEMPERATURES.



The probe can be heated to facilitate removal from frozen foods, see page 50.

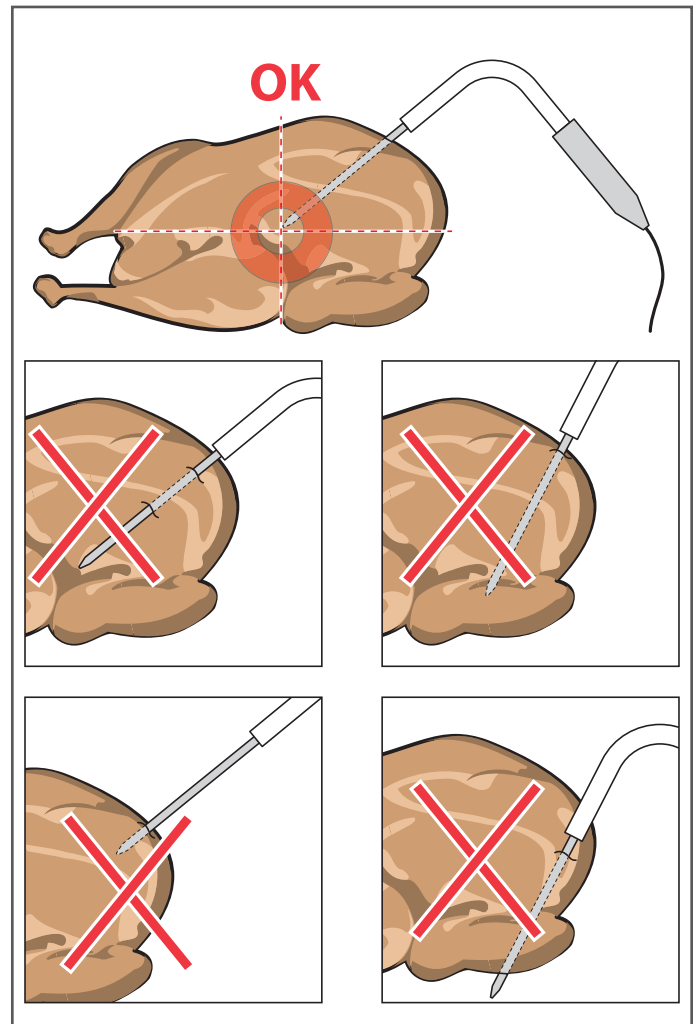

Rack adjustment for GASTRONORM or 600X400 trays

GASTRONORM

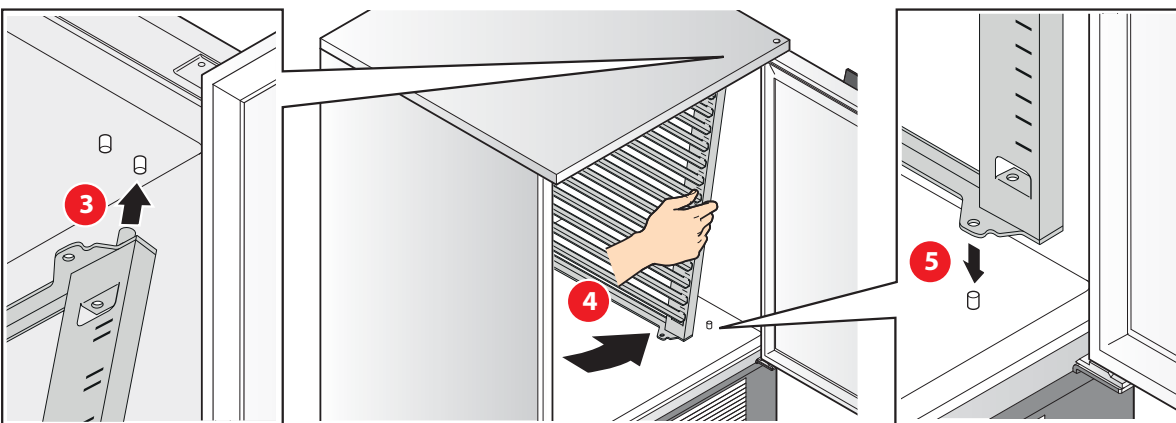
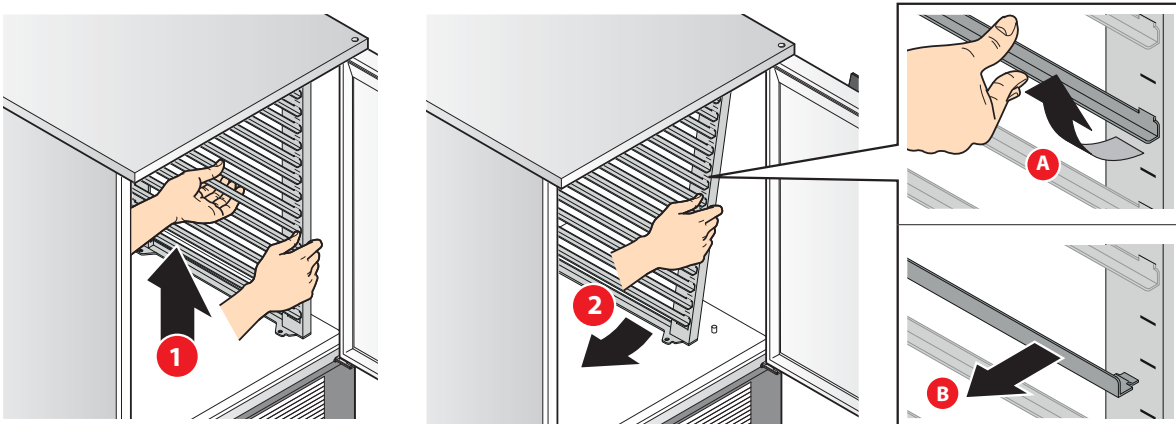
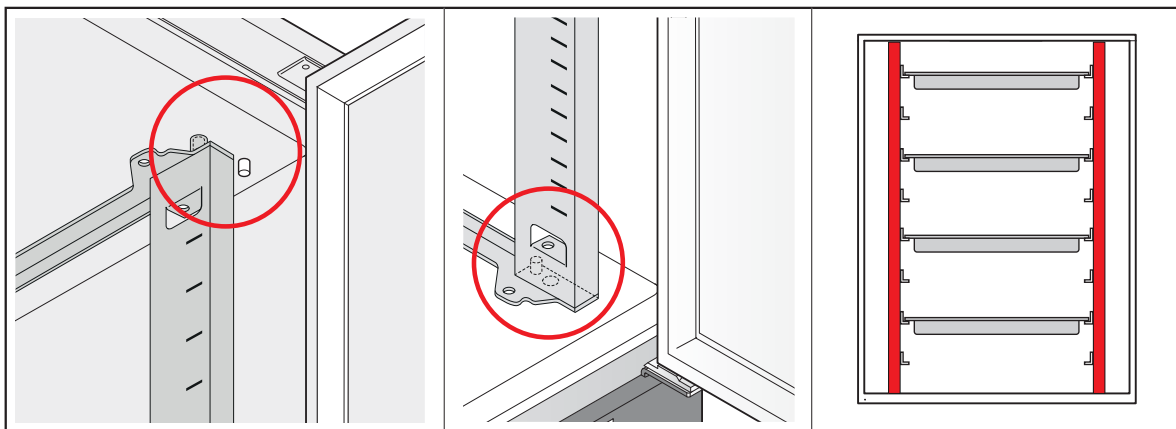

PASTRY 600x400

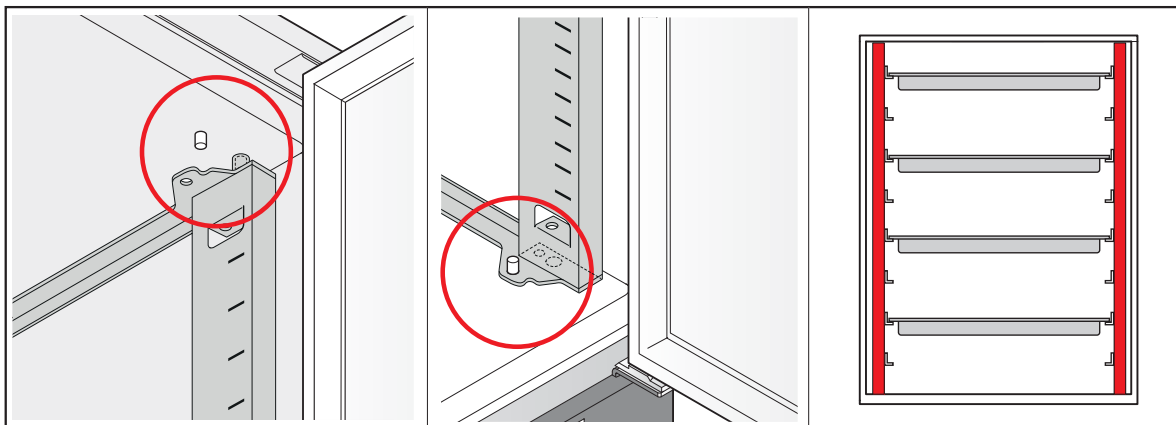

LEARNING ABOUT THE DEVICE

Turning on and off

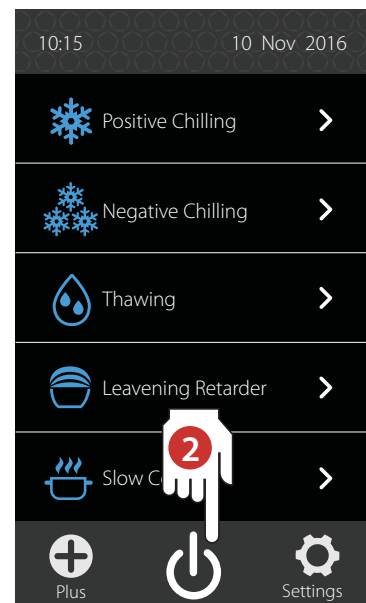
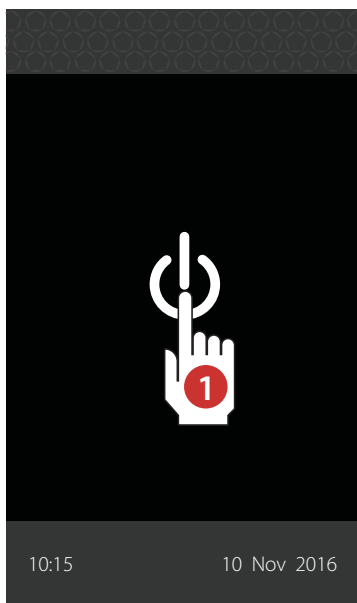
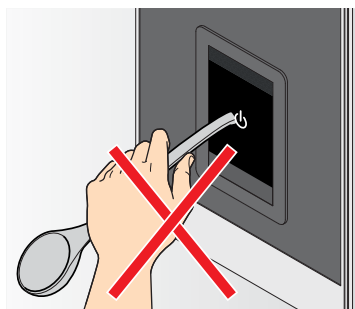
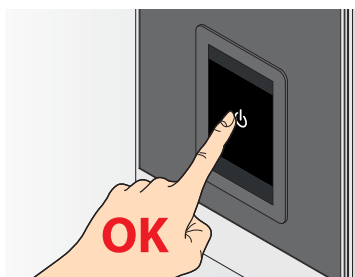

Main screen

- 1 To turn the equipment on, touch the ON/OFF key: the main screen appears.
- 2 At the end of work, touch the ON/OFF key in the main screen to turn the equipment off.

Keyboard lock and unlock

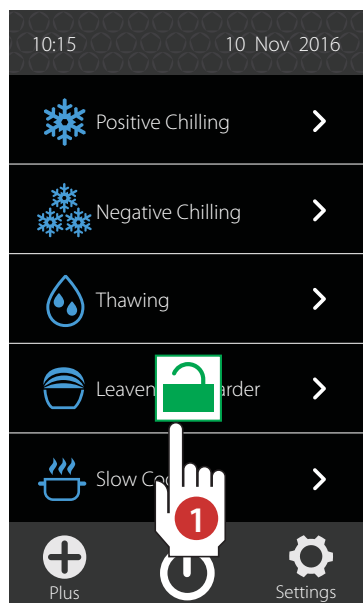

Beep
Beep
Beep

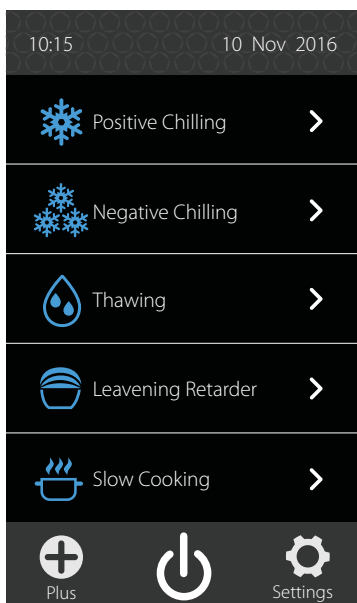

After several minutes of disuse, the keyboard automatically locks to prevent the cycle in progress from being accidentally stopped.

- 1 To unlock the keyboard, touch the **green padlock** on the display, the buzzer emits three beeps to indicate the keyboard was unlocked.

Initial settings

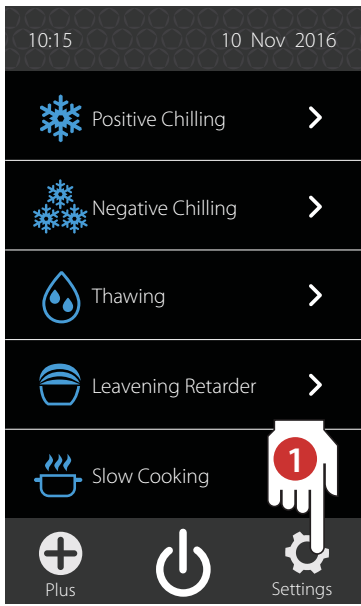

Main screen

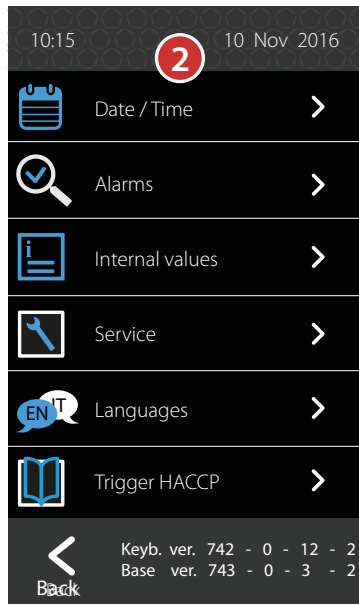

Settings screen

- 1 Touch the **Settings** key
- 2 The illustrated screen appears (settings screen).

Language settings



Language screen

Date and time settings

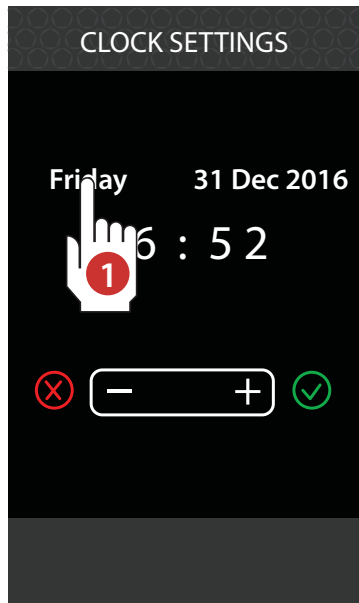

Date and time screen

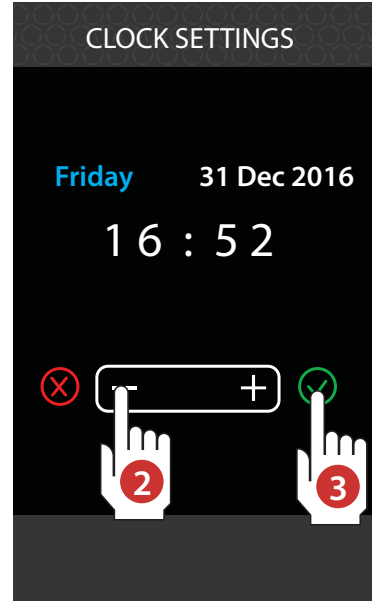

USE INITIAL SETTINGS

- 1 Touch the required language: the word **Back** under the key will change according to the selected language.
- 2 Confirm with key

- 1 Touch the value to be set (the day of the week in the example): the value will turn blue.
- 2 Use keys - and + to set the required value.
- 3 Save settings with ✓ or clear entered values with ✗. In both cases, the settings screen is displayed.

Alarms Service



For further information on alarms, see page 67.
For further information on SERVICE, see page 55.

Trigger HACCP

FIRST PAGE: if an item (e.g. chamber probe) is flagged, its data will be downloaded when HACCP log data is downloaded to a USB key.

SECOND PAGE: The temperatures of all sensors/probes in the list

in the first page applied to the machine can be viewed. All relays that interact for machine operations are in the list. If ON, the function is currently running.

THIRD PAGE: external digital inputs to the board, such as high and low pressure gauges (generate alarm in on), safety thermostat (generates alarm in on), door switch in ON are listed according to the functions running at that time on/off/delay/etc. utilities.

Positive Chilling with saved recipe (Cookbook) page 14

Positive Chilling with automatic or manual cycles page 17

Positive Storage page 18

Saving the completed Positive Chilling cycle page 19

The Positive Chilling function rapidly brings the product core temperature, fresh or cooked, to +3°C.



It is always best to pre-cool the cell before starting a Positive Chilling +3°C cycle. For further information on how to run a pre-cooling function, see page 51.

Positive Chilling with saved recipe (Cookbook)

- 1 Select the **Positive Chilling** cycle from the main screen touching the corresponding icon.
- 2 Select the icon for the food to be chilled ("MEAT" in the example).



meat *



fish *



vegetables *



first courses *



croissant



bread



cakes



creams sauces

* icons not included in pastry version

- 3 Touch the **Cookbook** icon.





- 4 Various factory set **Positive Chilling** cycles are displayed, all dedicated to the selected product category ("MEAT" in the example). Touch the corresponding name, for example, "RABBIT ROAST". If the right cycle for the dish to be chilled is not found, run **Positive Chilling with automatic or manual cycles**.



For further information on automatic or manual cycles, see page 17.

Default cycles for the "MEAT" family: the symbols before the recipe name indicate:

 the cycle ends at the end of the set time, thus the probe need not be inserted in the core of the food to be chilled

 the cycle ends when the set core temperature is reached, thus the probe must be inserted in the core of the food to be chilled.

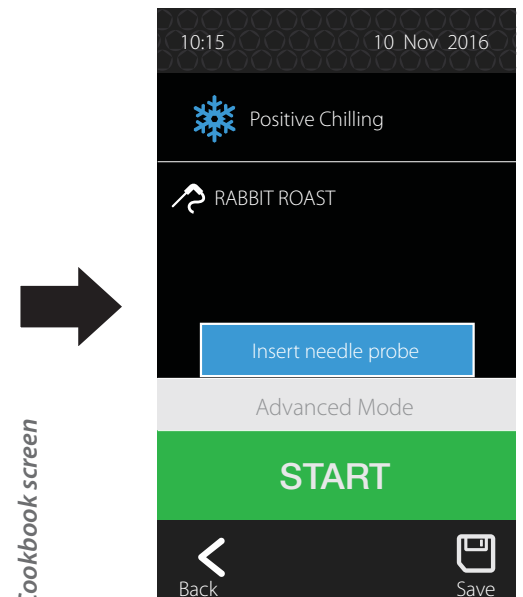
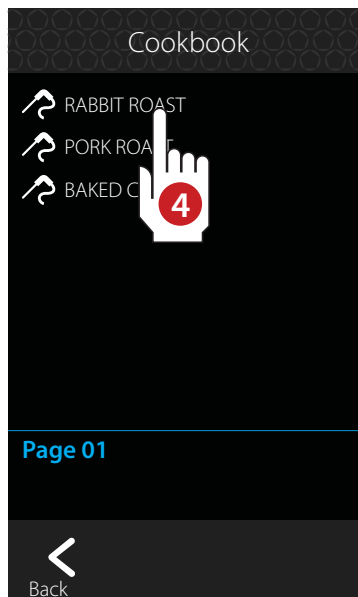

5 To start the positive chilling cycle, touch **START**, to stop it in advance, touch **STOP**.
 If the cycle includes a needle probe, a message (**Insert needle probe**) reminds the user to insert it.

START screen

chamber temperature icon
 - white: compressor OFF
 - blue: compressor ON
 - blinking: compressor waiting for short interval restarts

time elapsed

access to more information

probe temperature or time remaining to end chilling

fan speed
 - white: fan ON
 - blue: fan OFF

At the end of the **Positive Chilling** cycle, the machine automatically switches to **Positive Storage** mode.

Editing saved recipes (Cookbook) and creating a personal recipe (My recipes)

Recipes in the **Cookbook** section CANNOT be deleted or PERMANENTLY changed. These settings can only be edited for the cycle to be run (changes are not permanent and are cleared when exiting the program). Settings can only be change before starting the cycle and not when running. Alternatively, the recipe changed by the user can be saved with another name (e.g. "RABBIT ROAST WITH POTATOES") and will be saved under **My recipes**.

- 6** If, before touching **START**, you decide to change default cycle settings ("RABBIT ROAST" in the example), touch **Advanced Mode**.
- 7** Make the required settings.
- 8** Save settings with or clear entered values with . In both cases, the "START" screen is displayed.

Screen START

Column temp. in chamber

Column fan speed

Column temp. needle probe

F1 - 25°C [fan icon] 25°C

F2 - 12°C [fan icon] 12°C

F3 - 1°C [fan icon] 3°C

Cons - 2°C [fan icon]

Needle probe temperature in **Phase 1**

Needle probe temperature in **Phase 2**

Needle probe temperature in **Phase 3**

7





8



At this point you can:

- A** Run the new set recipe by touching **START**, remembering that the changes made will only be applied to the cycle to be run;
- B** Save the new recipe under a new name; later, to use this and all other personal recipes, touch the **My recipe** icon: the full list of recipes saved by the user will appear. To view saved recipes, scroll the pages by touching the blue recipes at the bottom (page 01, 02). Touch the recipe to be run.

To save a recipe with a new name, continue the procedure:

- 9** Save the new recipe by touching .
- 10 11 12** Enter the recipe name using the keypad ("RABBIT ROAST WITH POTATOES" in the example), confirm the name with  or clear with  and select the position where the recipe will be saved (position 02 in the example which is the first free position).
- 13** Confirm the selected position with  or cancel with . If the selected position is already occupied by another recipe, a warning to be confirmed appears on the display ("**Overwrite the existing recipe in place 01**").

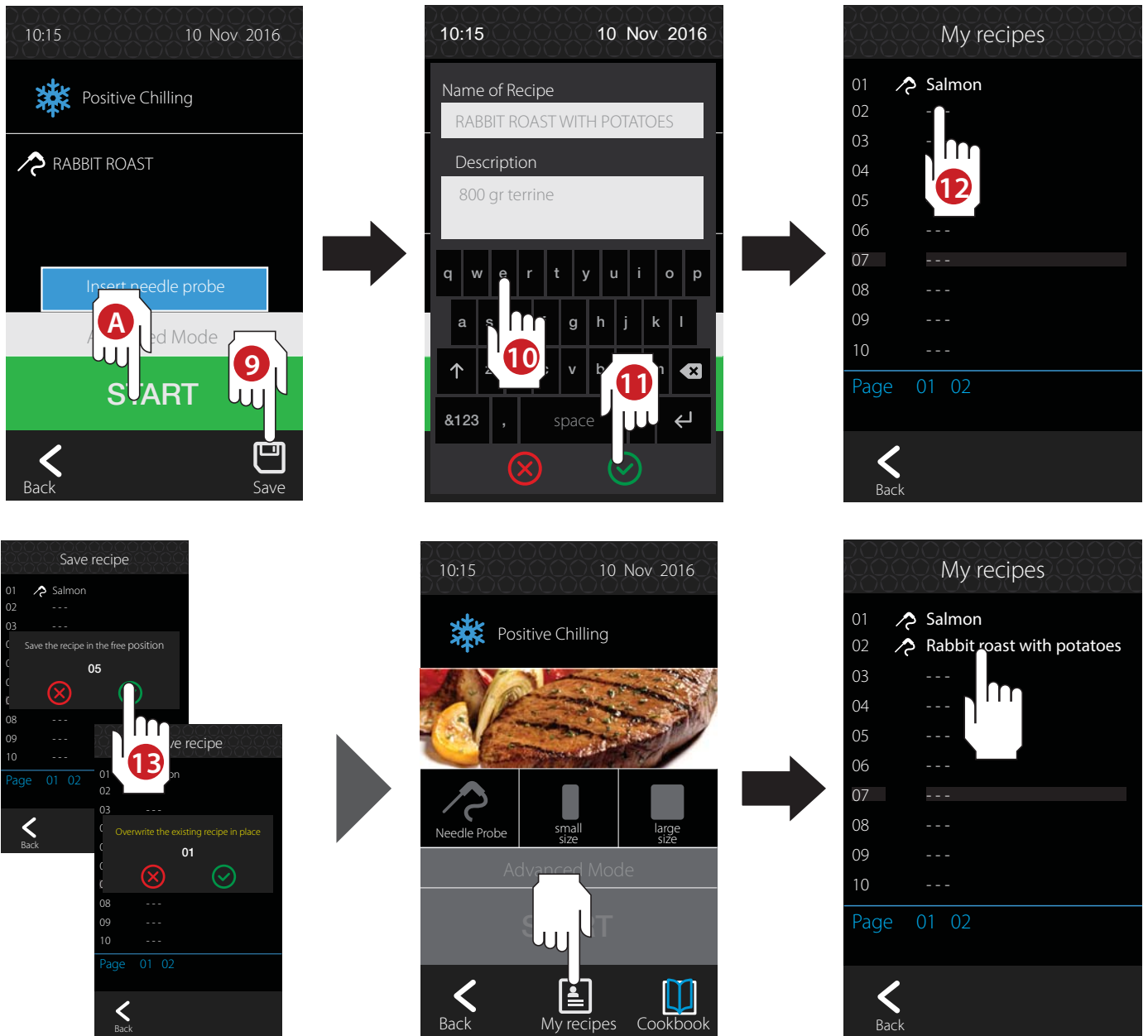

Positive Chilling with automatic or manual cycles

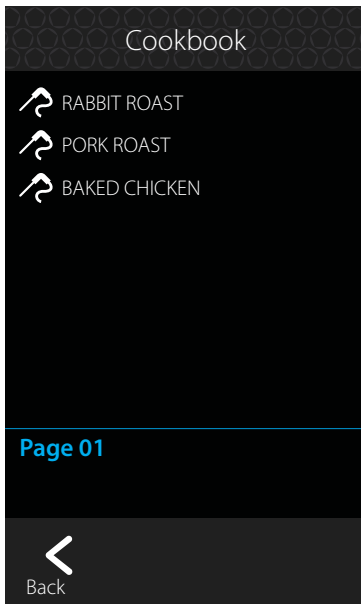

Cookbook screen

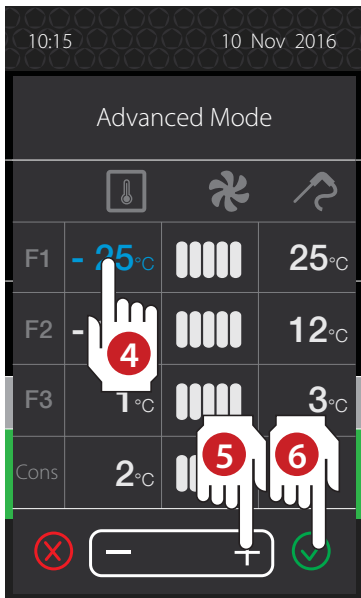
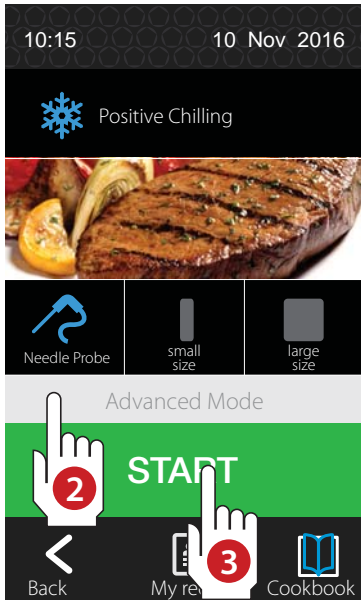
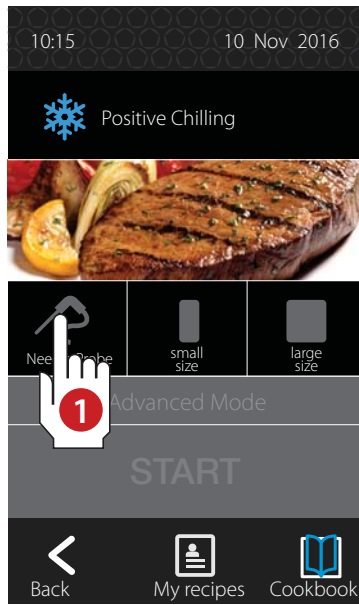

Advanced Mode screen with needle probe (automatic)

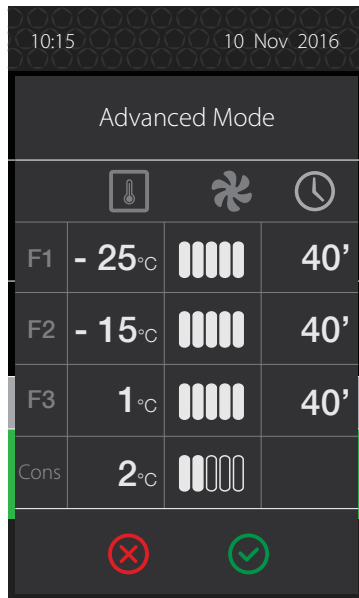

Advanced Mode screen (timed manual)

If, having selected a product category (for example "MEAT"), no recipe is found for the food to be chilled, three types of cycles can be used:

- **needle probe** (automatic cycle with probe at core),
- **small size** (manual cycle, timed, small food chilling)
- **large size** (manual cycle, timed, large food chilling)

The last two do not require the needle probe but a set chilling time (editable).

- 1 Select the cycle to be run.
- 2 Touch **Advanced Mode** to view selected cycle settings.
- 3 If the settings meet your needs, run the positive chilling cycle by pressing **START**.
- 4 Otherwise, in the **Advanced Mode** screen for each of the 3 **Chilling** (F1...F3) and **Storage** (Cons) phases you can set:

 cell temperature

 fan speed

 core temperature (automatic cycle)

 chilling time (manual cycle)

Changes will only apply to this cycle (changes are not permanent and are deleted by exiting the program).

Each phase ends when the needle probe reaches the set temperature (automatic cycle) or when the set time elapses (manual timed cycle).



Positive Storage



During the **Positive Storage** phase (which automatically follows each **Positive Chilling** cycle) the cell temperature is kept at +2°C.

Fan speed can be adjusted by other storage parameters cannot be changed.



Press **STOP** to end the cycle.

When a cycle is interrupted due to a blackout or other reasons, the green area, that indicates the storage phase, turns red.





Saving the completed Positive Chilling cycle

Cycles that ended and normally moved on to the storage phase can be saved in **My recipes**.

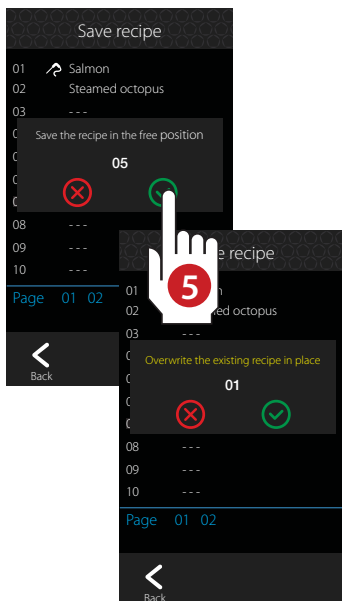
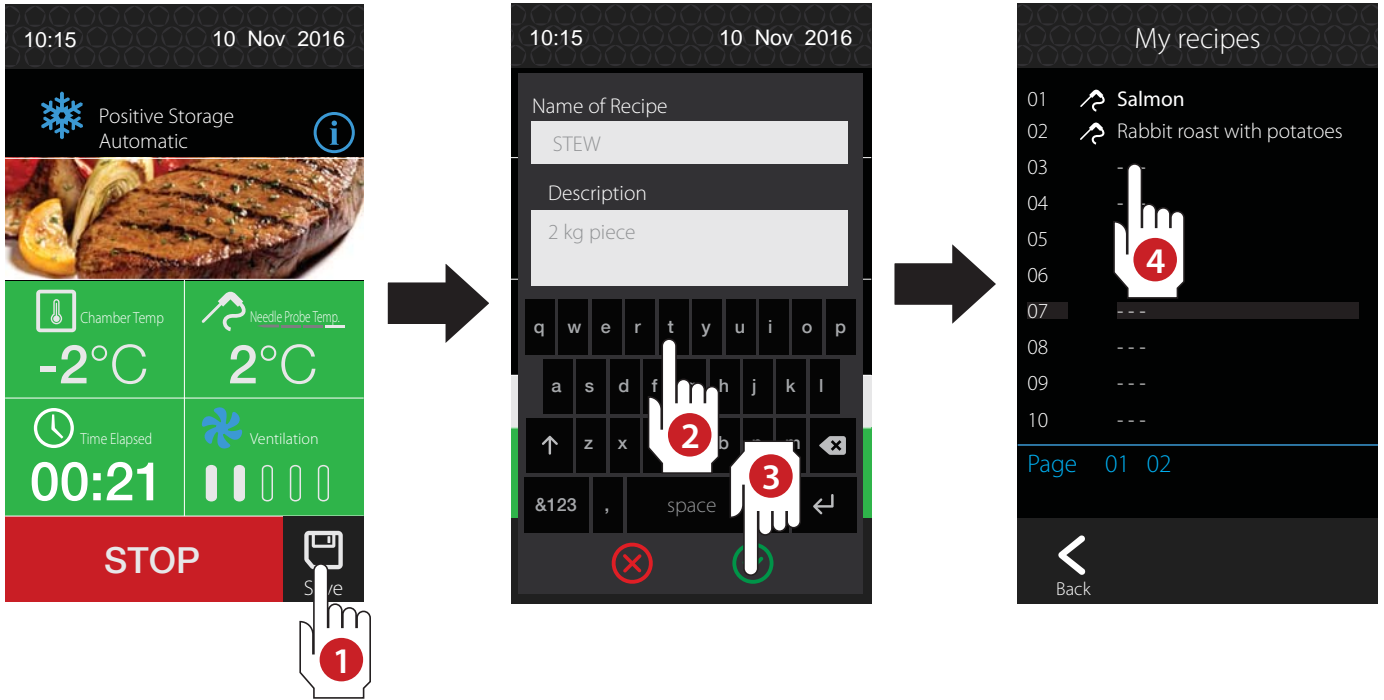
- 1 Save the ended cycle by touching .
- 2 3 4 Enter the recipe name using the keypad ("STEW" in the example), confirm the name with  or clear with  and select the position where the recipe will be saved (position 03 in the example which is the first free position).



- 5 Confirm the selected position with  or cancel with . If the selected position is already occupied by another recipe, a warning to be confirmed appears on the display ("Overwrite the existing recipe in place 01").



When fan speed is changed during chilling, the initial fan value is saved.

The recipe is saved in the memory space for **Positive Chilling** and for the product category (e.g. "MEAT").

All cycles saved in **My recipes** FROM COMPLETED CYCLE, are the repetitions of times and temperatures recorded during operations and do not require the needle probe (indicated by the clock symbol  next to the recipe name).

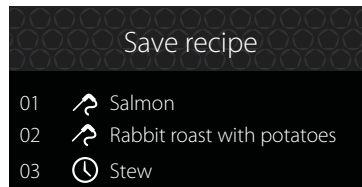



My recipe cycles saved from a COMPLETED CYCLE must only be used with the same type of food and size as the completed cycle.



Default values for automatic or manual Positive Chilling cycles (+3°C)

 MEAT*	Phase 1	Phase 2	Phase 3	Storage phase
	WITH PROBE			
Set Cell	-30 °C	-15 °C	1 °C	2 °C
Fan speed	5	5	5	2
Set Core	25 °C	12 °C	3 °C	--
	SMALL SIZE			
Set Cell	-20 °C	-12 °C	1 °C	2 °C
Fan speed	5	5	5	2
Time	30'	30'	20'	--
	LARGE SIZE			
Set Cell	-25 °C	-15 °C	1 °C	2 °C
Fan speed	5	5	5	2
Time	30'	30'	30'	--

 FISH*	Phase 1	Phase 2	Phase 3	Storage phase
	WITH PROBE			
Set Cell	-5 °C	-5 °C	1 °C	2 °C
Fan speed	5	5	5	2
Set Core	30 °C	30 °C	3 °C	--
	SMALL SIZE			
Set Cell	-5 °C	-5 °C	1 °C	2 °C
Fan speed	5	5	5	2
Time	15'	0'	25'	--
	LARGE SIZE			
Set Cell	-5 °C	-5 °C	1 °C	2 °C
Fan speed	5	5	5	2
Time	20'	0'	30'	--

 VEGETABLES*	Phase 1	Phase 2	Phase 3	Storage phase
	WITH PROBE			
Set Cell	-5 °C	-5 °C	1 °C	2 °C
Fan speed	5	5	5	2
Set Core	30 °C	30 °C	3 °C	--
	SMALL SIZE			
Set Cell	-5 °C	-5 °C	1 °C	2 °C
Fan speed	5	5	5	2
Time	10'	0'	30'	--
	LARGE SIZE			
Set Cell	-5 °C	-5 °C	1 °C	2 °C
Fan speed	5	5	5	2
Time	20'	0'	30'	--

* cycles not included in pastry version

	Phase 1	Phase 2	Phase 3	Storage phase
FIRST COURSES*	WITH PROBE			
Set Cell	-2 °C	-2 °C	0 °C	2 °C
Fan speed	5	5	5	2
Set Core	30 °C	30 °C	3 °C	--
	SMALL SIZE			
Set Cell	-2 °C	-2 °C	1 °C	2 °C
Fan speed	5	5	5	2
Time	30'	0'	15'	--
	LARGE SIZE			
Set Cell	-2 °C	-2 °C	1 °C	2 °C
Fan speed	5	5	5	2
Time	40'	0'	20'	--

	Phase 1	Phase 2	Phase 3	Storage phase
CROISSANT	WITH PROBE			
Set Cell	-5 °C	-5 °C	1 °C	2 °C
Fan speed	5	5	5	2
Set Core	25 °C	25 °C	3 °C	--
	SMALL SIZE			
Set Cell	-5 °C	-5 °C	1 °C	2 °C
Fan speed	5	5	5	2
Time	25'	0'	30'	--
	LARGE SIZE			
Set Cell	-5 °C	-5 °C	1 °C	2 °C
Fan speed	5	5	5	2
Time	30'	0'	30'	--

	Phase 1	Phase 2	Phase 3	Storage phase
BREAD	WITH PROBE			
Set Cell	-5 °C	-5 °C	1 °C	2 °C
Fan speed	5	5	5	2
Set Core	40 °C	40 °C	3 °C	--
	SMALL SIZE			
Set Cell	-5 °C	-5 °C	1 °C	2 °C
Fan speed	5	5	5	2
Time	20'	0'	30'	--
	LARGE SIZE			
Set Cell	-5 °C	-5 °C	0 °C	2 °C
Fan speed	5	5	5	2
Time	20'	0'	40'	--

* cycles not included in pastry version

POSITIVE CHILLING +3°C



 CAKES	Phase 1	Phase 2	Phase 3	Storage phase
	WITH PROBE			
Set Cell	-5 °C	-5 °C	1 °C	2 °C
Fan speed	5	5	5	2
Set Core	25 °C	25 °C	3 °C	--
SMALL SIZE				
Set Cell	-5 °C	-5 °C	1 °C	2 °C
Fan speed	5	5	5	2
Time	40'	0'	20'	--
LARGE SIZE				
Set Cell	-5 °C	-5 °C	1 °C	2 °C
Fan speed	5	5	5	2
Time	60'	0'	30'	--

 CREAMS - SAUCES	Phase 1	Phase 2	Phase 3	Storage phase
	WITH PROBE			
Set Cell	-20 °C	-5 °C	0 °C	2 °C
Fan speed	5	5	5	2
Set Core	30 °C	12 °C	3 °C	--
SMALL SIZE				
Set Cell	-20 °C	-5 °C	0 °C	2 °C
Fan speed	5	5	5	2
Time	30'	20'	20'	--
LARGE SIZE				
Set Cell	-20 °C	-5 °C	1 °C	2 °C
Fan speed	5	5	5	2
Time	35'	20'	35'	--

Negative Chilling with saved recipe (Cookbook) page 23

Negative Chilling with automatic or manual cycles page 23

Negative Storage page 27

Saving the completed Negative Chilling cycle page 28

The purpose of the Negative Chilling cycle is to rapidly bring the fresh or cooked product core temperature to -18°C.



It is always best to pre-cool the cell before starting a Negative Chilling -18°C cycle. For further information on how to run a pre-cooling function, see page 51.

Negative Chilling with saved recipe (Cookbook)

- 1 Select the **Negative Chilling** cycle from the main screen touching the corresponding icon.
- 2 Select the icon for the food to be chilled ("MEAT" in the example).

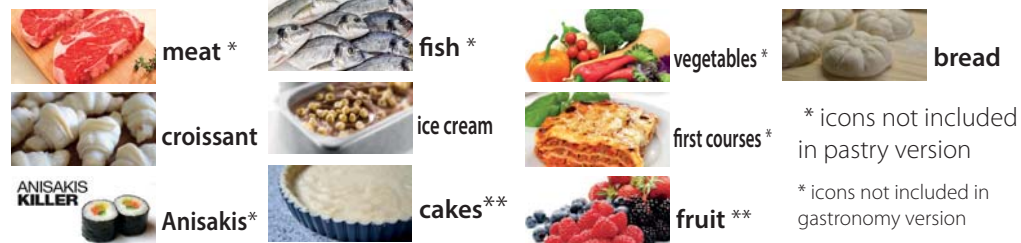

- 3 Touch the **Cookbook** icon.



- 4 Various factory set **Negative Chilling** cycles are displayed, all dedicated to the selected product category ("MEAT" in the example). Touch the corresponding name, for example "COOKED MEAT FREEZING": if the right cycle for the dish to be chilled is not found, run **Negative Chilling with automatic or manual cycles**.



For further information on automatic or manual cycles, see page 26.

Default cycles dedicated to the "MEAT" family.

The symbols before the recipe name indicate:

the cycle ends at the end of the set time, thus the probe need not be inserted in the core of the food to be chilled

the cycle ends when the set core temperature is reached, thus the probe must be inserted in the core of the food to be chilled.

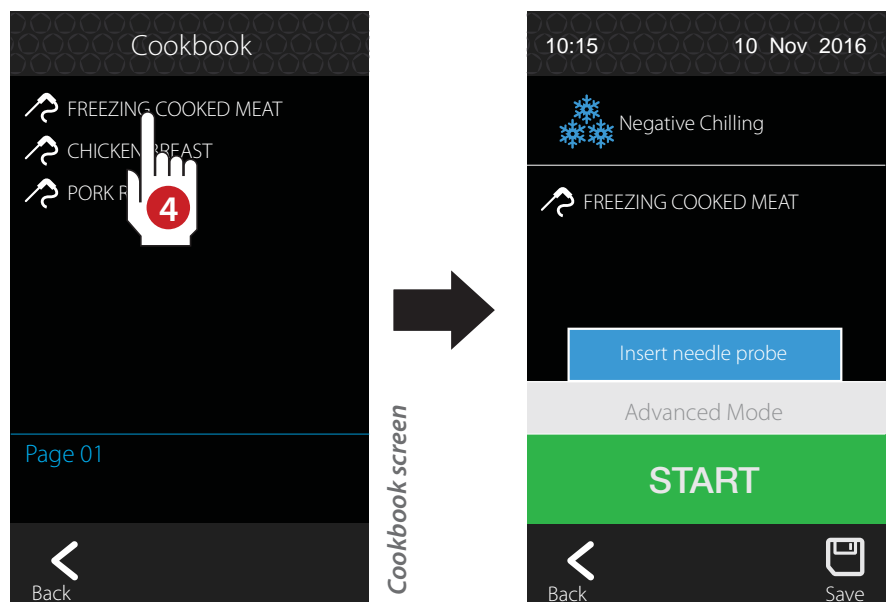

5 To start the negative chilling cycle, touch **START**, to stop it in advance, touch **STOP**.

If the cycle includes a needle probe, a message (**Insert needle probe**) reminds the user to insert it.

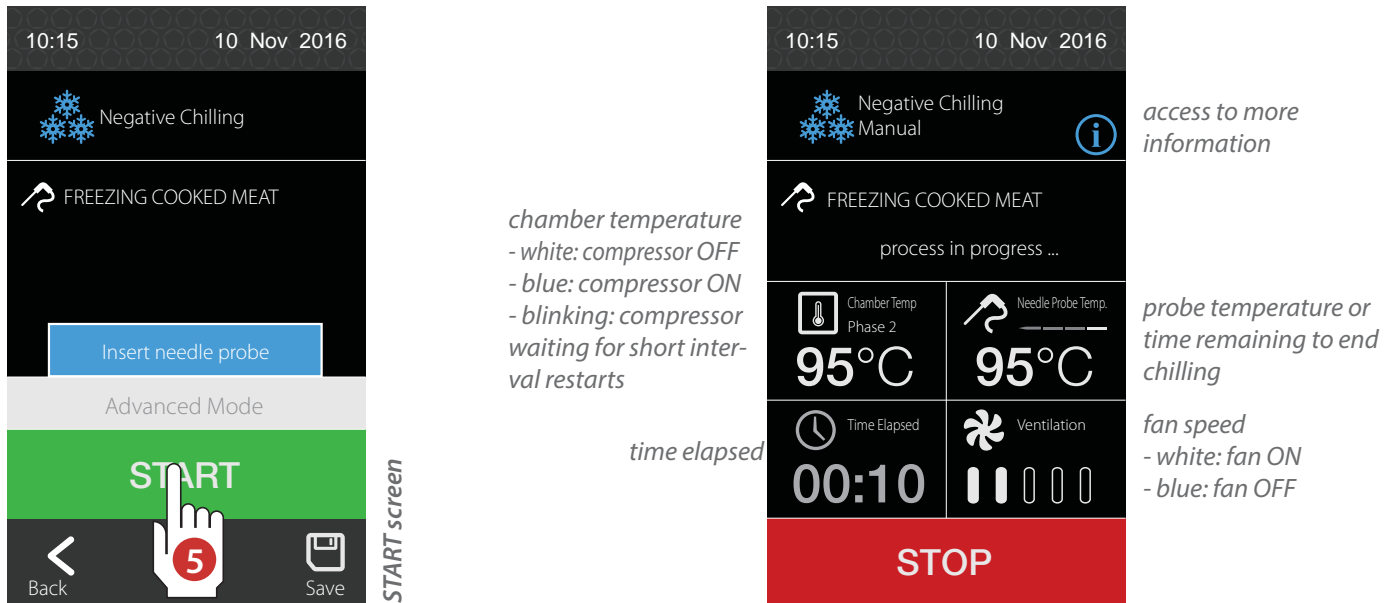

At the end of the **Negative Chilling** cycle, the machine automatically switches to **Negative Storage** mode.

Editing saved recipes (Cookbook) and creating a personal recipe (My recipes)

Recipes in the **Cookbook** section CANNOT be deleted or PERMANENTLY changed.

These settings can only be edited for the cycle to be run (changes are not permanent and are cleared when exiting the program). Settings can only be changed before starting the cycle and not when running.

Alternatively, the recipe changed by the user can be saved with another name (e.g. "ROAST BEEF") and will be saved under **My recipes**.



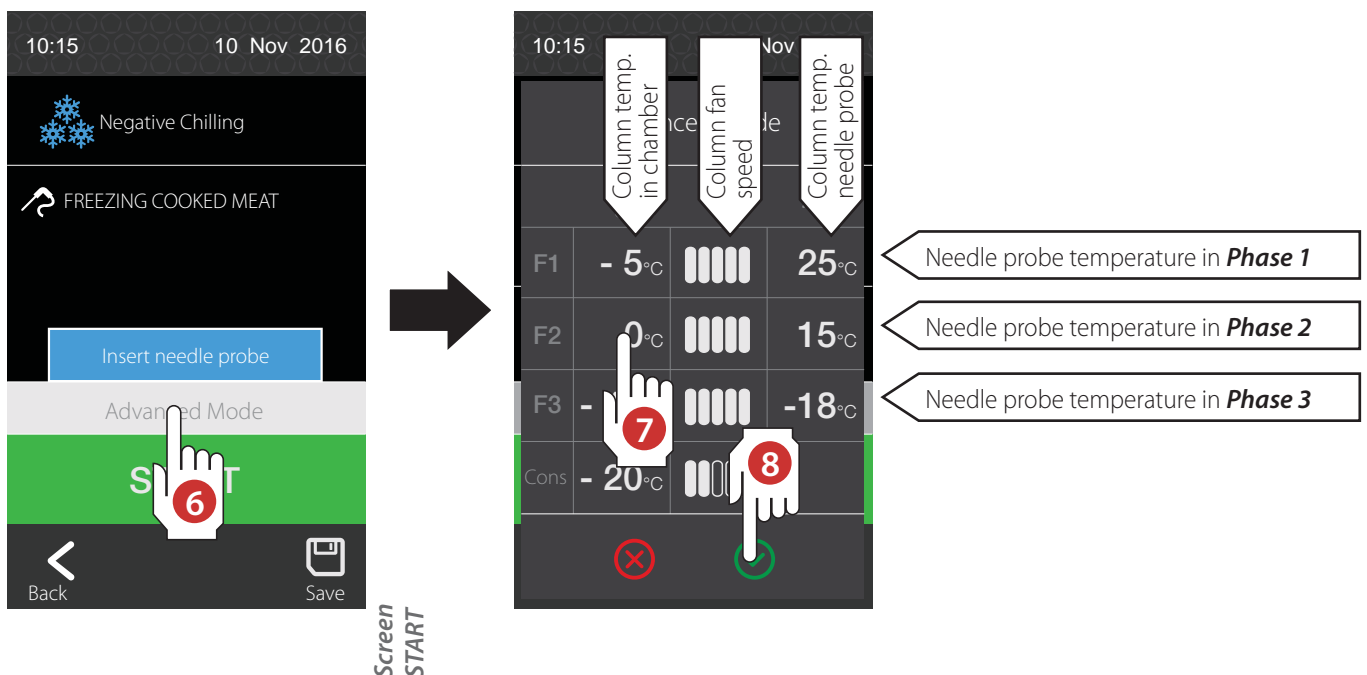

- 6** If, before touching **START**, you decide to change default cycle settings ("COOKED MEAT FREEZING" in the example), touch **Advanced Mode**.
- 7** Make the required settings.
- 8** Save settings with or clear entered values with . In both cases, the "START" screen is displayed.



At this point you can:

- A** Run the new set recipe by touching **START**, remembering that the changes made will only be applied to the cycle to be run;
- B** Save the new recipe under a new name; later, to use this and all other personal recipes, touch the **My recipe** icon: the full list of recipes saved by the user will appear. To view saved recipes, scroll the pages by touching the blue recipes at the bottom (page 01, 02). Touch the recipe to be run.

To save a recipe with a new name, continue the procedure:

- 9** Save the new recipe by touching .
- 10 11 12** Enter the recipe name using the keypad ("ROAST BEEF" in the example), confirm the name with  or clear with  and select the position where the recipe will be saved (position 02 in the example which is the first free position).
- 13** Confirm the selected position with  or cancel with . If the selected position is already occupied by another recipe, a warning to be confirmed appears on the display ("Overwrite the existing recipe in place 01").

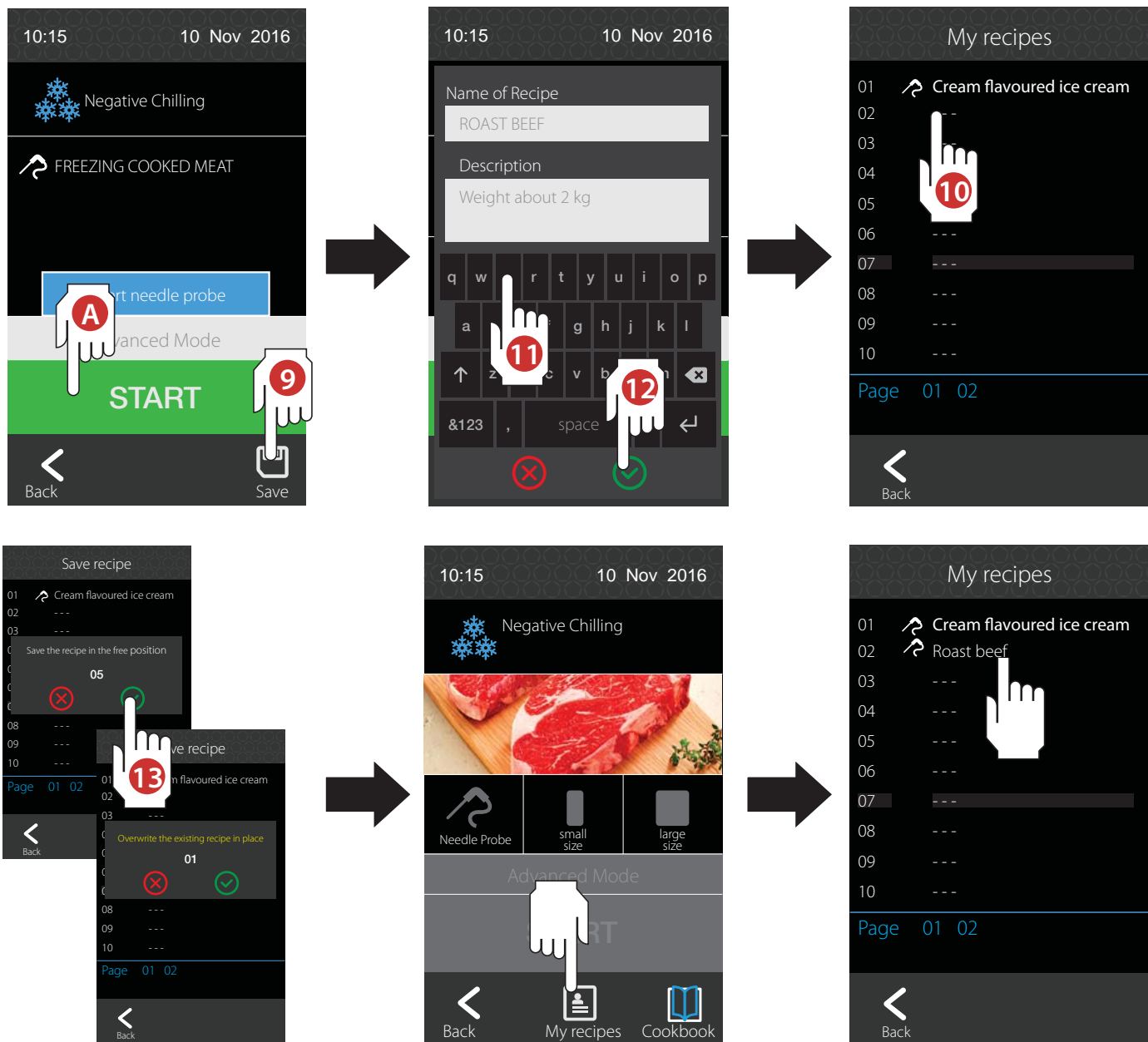

NEGATIVE CHILLING -18°C



Negative Chilling with automatic or manual cycles

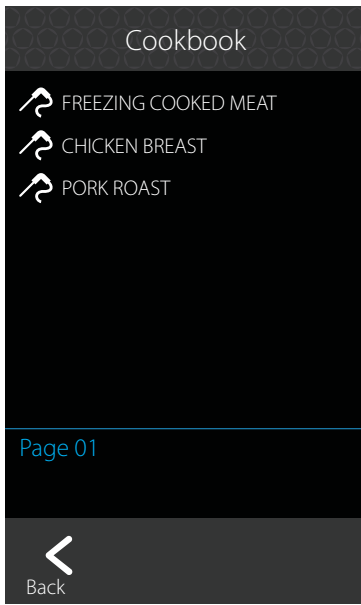

Cookbook screen

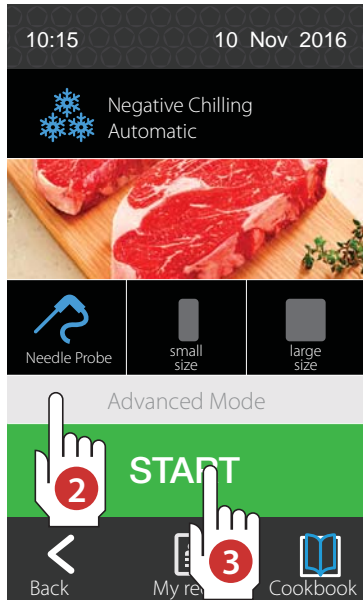

Settings can only be change before starting the cycle and not when running.

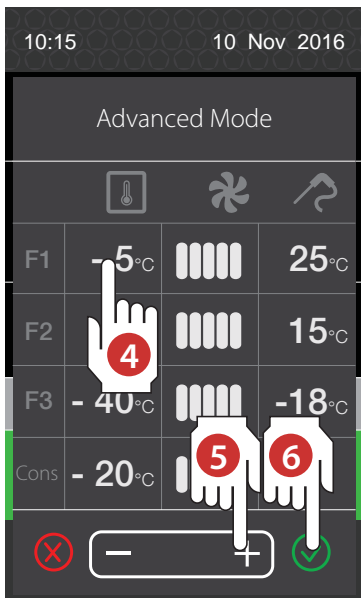

Advanced Mode screen with needle probe (automatic)

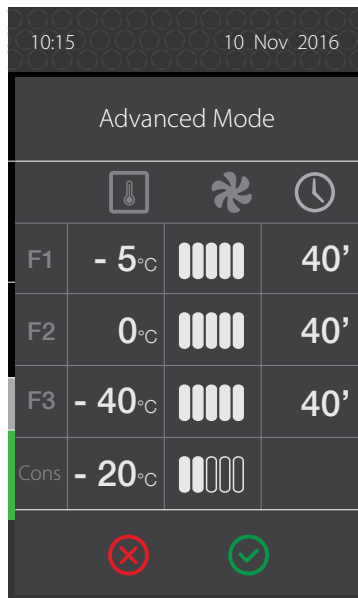

Advanced Mode screen (timed manual)

If, having selected a product category (for example "MEAT"), no recipe is found for the food to be chilled, three types of cycles can be used:

- **needle probe** (automatic cycle with probe at core),
- **small size** (manual cycle, timed, small food chilling)
- **large size** (manual cycle, timed, large food chilling)

The last two do not require the needle probe but a set chilling time.

- 1 Select the cycle to be run.
- 2 Touch **Advanced Mode** to view selected cycle settings.
- 3 If the settings meet your needs, run the **Negative Chilling** cycle by pressing **START**.
- 4 Otherwise, in the **Advanced Mode** screen for each of the 3 **Chilling** (F1...F3) and **Storage** (Cons) phases you can set:

- cell temperature
- fan speed
- core temperature (automatic cycle)
- chilling time (manual cycle)

Changes will only apply to this cycle (changes are not permanent and are deleted by exiting the program).

Each phase ends when the needle probe reaches the set temperature (automatic cycle) or when the set time elapses (manual timed cycle).

Negative Storage

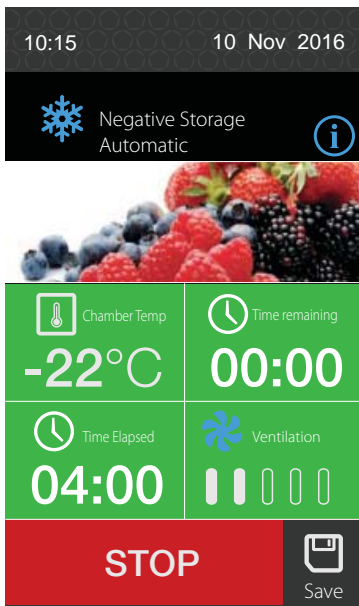

During the **Negative Storage** phase (which automatically follows each **Negative Chilling** cycle) the cell temperature is kept at -20°C.

Fan speed can be adjusted but other storage parameters cannot be changed.

Press **STOP** to end the cycle.



When a cycle is interrupted due to a blackout or other reasons, the green area, that indicates the storage phase, turns red.

Anisakis killer (fish sanitation cycle)

1 Insert the probe in the food to be frozen.

2 Press the "Anisakis Killer": key. A fish sanitation cycle starts divided into the following three phases:

- **Negative chilling** with **chamber** set to -40°C (parameter AK1) until needle probe reaches -20°C (parameter AK2).

- **Maintenance** for 24 hours (parameter AK3) with chamber set point at -20°C (parameter AK2).

- **Negative storage** with chamber set point at -20°C (parameter AK4).

When the temperature read by the needle probe reaches the end **Negative chilling** temperature, the device automatically switches to **Maintenance**. After the maintenance period, the device automatically switches to **Negative storage**.

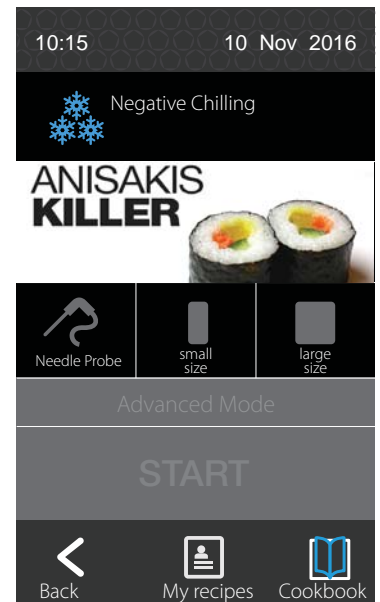
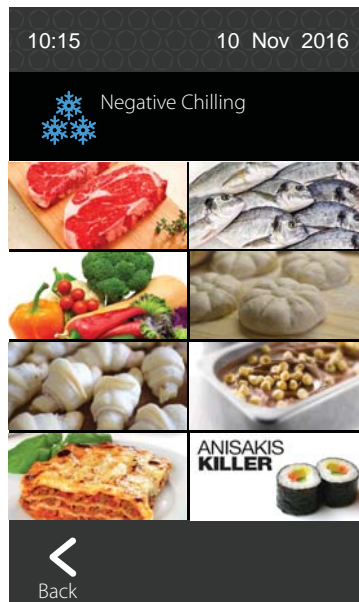
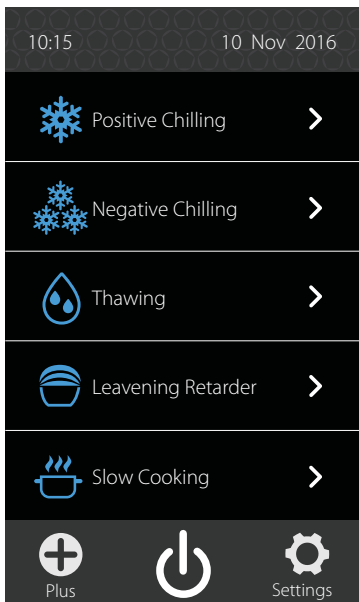



ANISAKIS

Anisakiasis is a parasitic infection of the gastrointestinal tract caused by eating raw or insufficiently cooked seafood products containing Anisakis simplex larvae: if the larvae penetrate the intestinal wall, they cause a violent abdominal pain, associated with nausea and vomiting. Should, one or two weeks after the infection, these succeed in passing into the intestines, a significant immune response can occur, with intermittent abdominal pain, nausea, diarrhoea and fever or intestinal perforation.





Saving the completed Negative Chilling cycle

Cycles that ended and normally moved on to the storage phase can be saved in **My recipes**.

- 1 Save the ended cycle by touching .
- 2 3 4 Enter the recipe name using the keypad ("PRE-COOKED BREAD" in the example), confirm the name with  or clear with  and select the position where the recipe will be saved (position 03 in the example which is the first free position).



- 5 Confirm the selected position with  or cancel with . If the selected position is already occupied by another recipe, a warning to be confirmed appears on the display ("**Overwrite the existing recipe in place 01**").



When fan speed is changed during chilling, the initial fan value is saved.

The recipe is saved in the memory space for **Negative Chilling** and for the product category (e.g. "MEAT").

All cycles saved in **My recipes** FROM COMPLETED CYCLE, are the repetitions of times and temperatures recorded during operations and do not require the needle probe (indicated by the clock symbol  next to the recipe name).

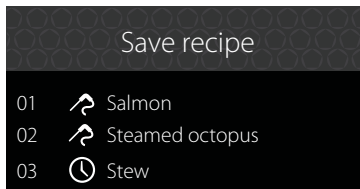
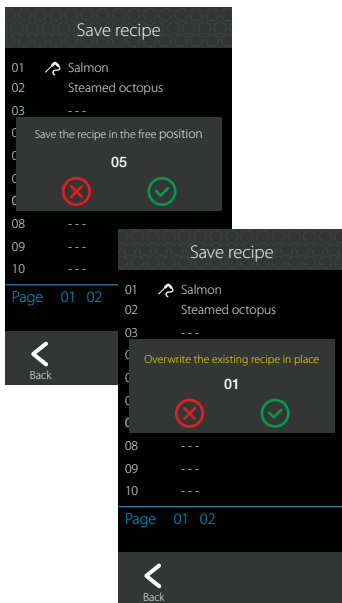

My recipe cycles saved from a COMPLETED CYCLE must only be used with the same type of food and size as the completed cycle.

Default values for automatic or manual Negative Chilling cycles (-18°C)

 MEAT*	Phase 1	Phase 2	Phase 3	Storage phase
	WITH PROBE			
Set Cell	-40 °C	-40 °C	-40 °C	-20 °C
Fan speed	5	5	5	2
Set Core	-18 °C	-18 °C	-18 °C	--
	SMALL SIZE			
Set Cell	-40 °C	-40 °C	-40 °C	-20 °C
Fan speed	5	5	5	2
Time	40'	40'	40'	--
	LARGE SIZE			
Set Cell	-40 °C	-40 °C	-40 °C	-20 °C
Fan speed	5	5	5	2
Time	80'	80'	80'	--

 FISH*	Phase 1	Phase 2	Phase 3	Storage phase
	WITH PROBE			
Set Cell	-40 °C	-40 °C	-40 °C	-20 °C
Fan speed	5	5	5	2
Set Core	-18 °C	-18 °C	-18 °C	--
	SMALL SIZE			
Set Cell	-40 °C	-40 °C	-40 °C	-20 °C
Fan speed	5	5	5	2
Time	30'	30'	30'	--
	LARGE SIZE			
Set Cell	-40 °C	-40 °C	-40 °C	-20 °C
Fan speed	5	5	5	2
Time	50'	50'	50'	--

 VEGETABLES*	Phase 1	Phase 2	Phase 3	Storage phase
	WITH PROBE			
Set Cell	-40 °C	-40 °C	-40 °C	-20 °C
Fan speed	5	5	5	2
Set Core	-18 °C	-18 °C	-18 °C	--
	SMALL SIZE			
Set Cell	-40 °C	-40 °C	-40 °C	-20 °C
Fan speed	5	5	5	2
Time	30'	30'	30'	--
	LARGE SIZE			
Set Cell	-40 °C	-40 °C	-40 °C	-20 °C
Fan speed	5	5	5	2
Time	40'	40'	40'	--

* cycles not included in pastry version



USE - NEGATIVE CHILLING -18°C

 BREAD	Phase 1	Phase 2	Phase 3	Storage phase
	WITH PROBE			
Set Cell	-35 °C	-35 °C	-35 °C	-20 °C
Fan speed	5	5	5	2
Set Core	-18 °C	-18 °C	-18 °C	--
	SMALL SIZE			
Set Cell	-35 °C	-35 °C	-35 °C	-20 °C
Fan speed	5	5	5	2
Time	20'	20'	20'	--
	LARGE SIZE			
Set Cell	-35 °C	-35 °C	-35 °C	-20 °C
Fan speed	5	5	5	2
Time	80'	80'	80'	--

 CROISSANT	Phase 1	Phase 2	Phase 3	Storage phase
	WITH PROBE			
Set Cell	-40 °C	-40 °C	-40 °C	-20 °C
Fan speed	5	5	5	2
Set Core	-18 °C	-18 °C	-18 °C	--
	SMALL SIZE			
Set Cell	-40 °C	-40 °C	-40 °C	-20 °C
Fan speed	5	5	5	2
Time	20'	20'	20'	--
	LARGE SIZE			
Set Cell	-40 °C	-40 °C	-40 °C	-20 °C
Fan speed	5	5	5	2
Time	25'	25'	25'	--

 ICE CREAM	Phase 1	Phase 2	Phase 3	Storage phase
	WITH PROBE			
Set Cell	-40 °C	-40 °C	-40 °C	-20 °C
Fan speed	5	5	5	2
Set Core	-18 °C	-18 °C	-18 °C	--
	SMALL SIZE			
Set Cell	-40 °C	-40 °C	-40 °C	-20 °C
Fan speed	5	5	5	2
Time	30'	30'	30'	--
	LARGE SIZE			
Set Cell	-40 °C	-40 °C	-40 °C	-20 °C
Fan speed	5	5	5	2
Time	80'	80'	80'	--

* cycles not included in pastry version

 FIRST COURSES*	Phase 1	Phase 2	Phase 3	Storage phase
WITH PROBE				
Set Cell	-40 °C	-40 °C	-40 °C	-20 °C
Fan speed	5	5	5	2
Set Core	-18 °C	-18 °C	-18 °C	--
SMALL SIZE				
Set Cell	-40°C	-40°C	-40°C	-20°C
Fan speed	5	5	5	2
Time	30'	0'	15'	--
LARGE SIZE				
Set Cell	-40 °C	-40 °C	-40 °C	-20 °C
Fan speed	5	5	5	2
Time	40'	40'	40'	--

 FRUIT**	Phase 1	Phase 2	Phase 3	Storage phase
WITH PROBE				
Set Cell	-40 °C	-40 °C	-40 °C	-20 °C
Fan speed	5	5	5	2
Set Core	-18 °C	-18 °C	-18 °C	--
SMALL SIZE				
Set Cell	-40 °C	-40 °C	-40 °C	-20 °C
Fan speed	5	5	5	2
Time	30'	30'	30'	--
LARGE SIZE				
Set Cell	-40 °C	-40 °C	-40 °C	-20 °C
Fan speed	5	5	5	2
Time	40'	40'	40'	--

 CAKES**	Phase 1	Phase 2	Phase 3	Storage phase
WITH PROBE				
Set Cell	-40 °C	-40 °C	-40 °C	-20 °C
Fan speed	5	5	5	2
Set Core	-18 °C	-18 °C	-18 °C	--
SMALL SIZE				
Set Cell	-40 °C	-40 °C	-40 °C	-20 °C
Fan speed	5	5	5	2
Time	20'	20'	20'	--
LARGE SIZE				
Set Cell	-40 °C	-40 °C	-40 °C	-20 °C
Fan speed	5	5	5	2
Time	25'	25'	25'	--

* cycles not included in pastry version

** cycles not included in gastronomy version

NEGATIVE CHILLING -18°C



USE - THAWING

The Thawing function lets you quickly thaw frozen foods.

- 1 Select the **Thawing** cycle from the main screen touching the corresponding icon.
- 2 three different thawing programs ARE possible, depending on the thickness of the product to be thawed.

Small size thickness less than or equal to 50 mm duration 60 min
 Medium size thickness between 50 - 100 mm duration 240 min
 Large size thickness over 100 mm duration 360 min

- 3 To start the **Thawing** cycle, touch **START**, to stop it in advance, touch **STOP**.

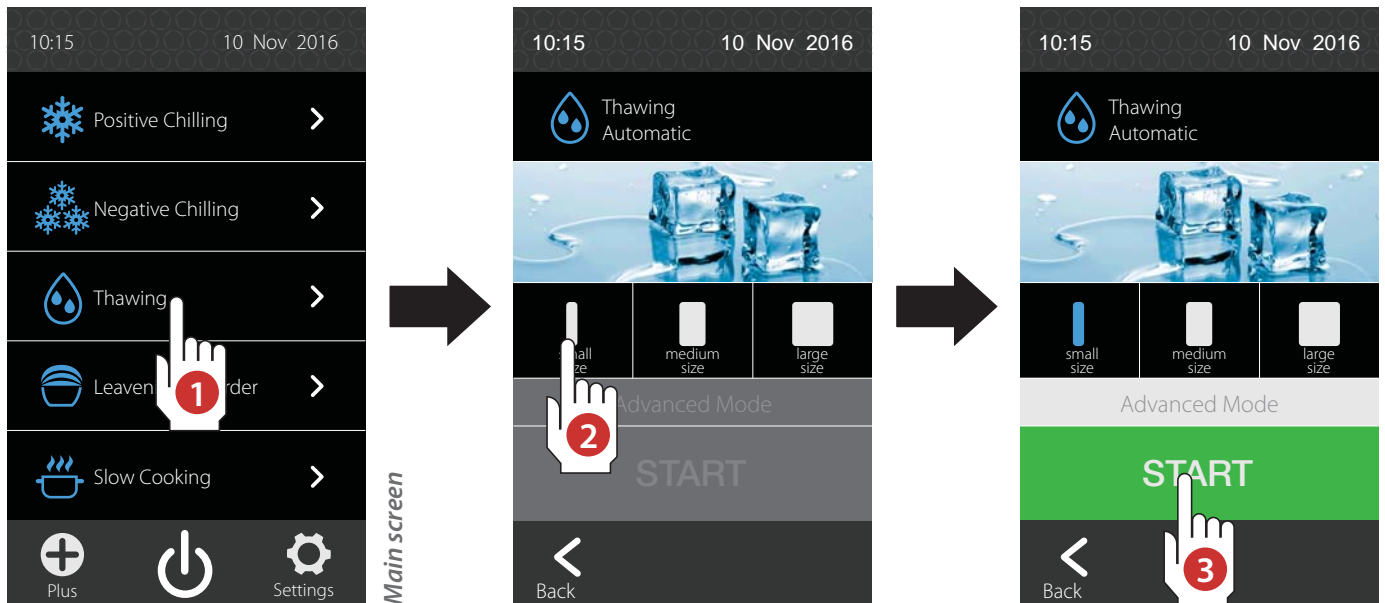

The **Thawing** cycle divides the total time into 5 phases (60, 240 or 360 minutes based on selected size).

Initially, during **Phase 1** (when the product is still frozen) the temperature is the **Initial Set Chamber** (20°, 25° or 30°C based on the selected size): this temperature is automatically reduced at each phase to reach the **Phase 5 End Set Chamber** (12°C).

After thawing, **Storage** (3°C) automatically begins, the buzzer sounds for several seconds and the display background switches from black to green while the message "**Thawing in progress**" in the **STOP** key turns to "**Storage in progress**": the thawing process has completed.



The addition of humidity is important if food is thawed on trays (they could lose weight and dehydrate) while these are not needed if closed in bags or containers.

Humidity to be added during the cycle can be set from 0 (no additional humidity) to rise to five levels, and can always be changed during the entire cycle by touching the humidity icon on the display.

Humidity is inhibited during the first part of the thawing cycle.

cell temperature
 humidity: editable from 0 to 5 at any time in the cycle



time remaining to the end of the thawing cycle

SMALL SIZE (th. ≤ 50 mm)	Set initial chamber Phase 1 (frozen product)	Phase 2	Phase 3	Phase 4	Set end chamber Phase 5 (thawed product)	Storage
Set Cell	20°C	automatic temp.	automatic temp.	automatic temp.	12°C	3°C
Fan speed	5	5	5	5	5	ON/OFF
Set Humidity	Adjustable from 0 (no humidity) to 5 (maximum humidity)					
Cycle duration (time)	60 minutes					

MEDIUM SIZE (th. 50 -100 mm)	Set initial chamber Phase 1 (frozen product)	Phase 2	Phase 3	Phase 4	Set end chamber Phase 5 (thawed product)	Storage
Set Cell	25°C	automatic temp.	automatic temp.	automatic temp.	12°C	3°C
Fan speed	5	5	5	5	5	ON/OFF
Set Humidity	Adjustable from 0 (no humidity) to 5 (maximum humidity)					
Cycle duration (time)	240 minutes					

LARGE SIZE (th. > 100 mm)	Set initial chamber Phase 1 (frozen product)	Phase 2	Phase 3	Phase 4	Set end chamber Phase 5 (thawed product)	Storage
Set Cell	30°C	automatic temp.	automatic temp.	automatic temp.	12°C	3°C
Fan speed	5	5	5	5	5	ON/OFF
Set Humidity	Adjustable from 0 (no humidity) to 5 (maximum humidity)					
Cycle duration (time)	360 minutes					

Editing thawing cycle parameters (optional)

- 4 If necessary, the user can change:
- cell temperature during Phase 1 - **Initial Set Chamber** (initial temperature in the cell when the product is still frozen);
 - cell temperature during Phase 5 - **End Set Chamber** (end thawing cycle cell temperature);
 - cycle duration (**Time**);
 - cell temperature during the **Storage** phase.

- 5 6 After settings, touch the **back** key and **START** key to start the thawing cycle.

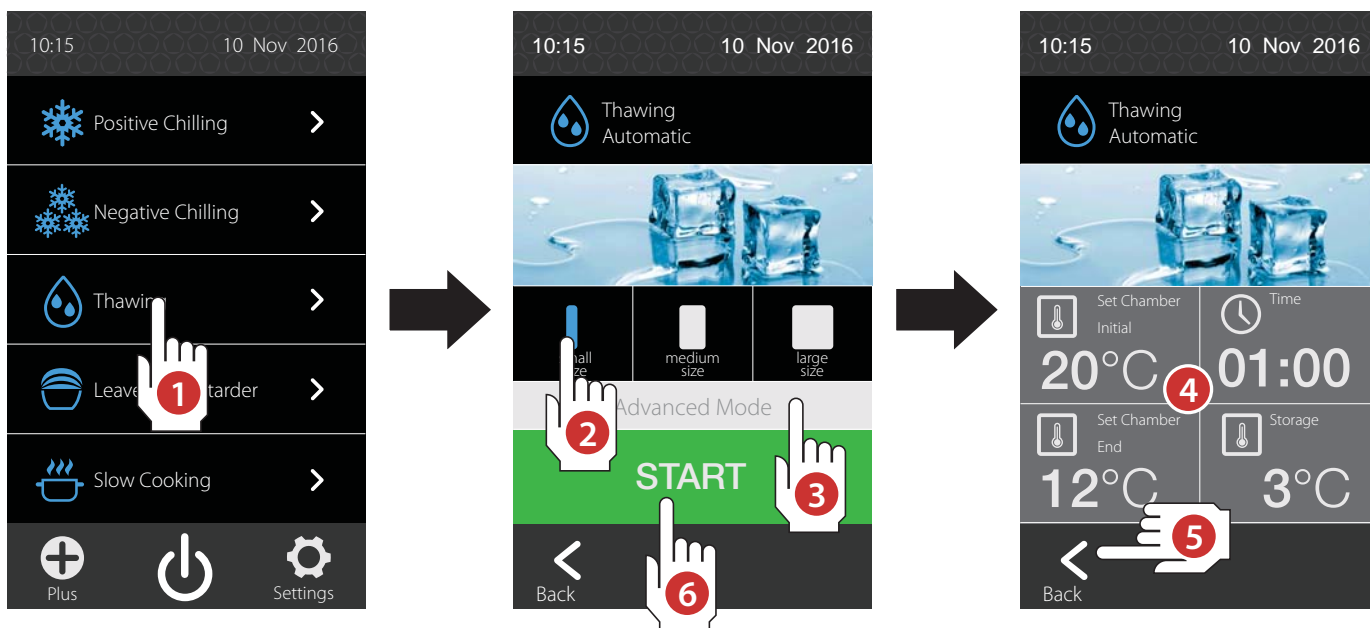

THAWING



Automatic Leavening Retarder
page 35

Manual Leavening Retarder
page 39

Manual Rising
page 42

Controlled leavening is used for bread and pastry doughs by managing temperature, humidity and time. This improves product quality and eliminates baker night shifts: dough is prepared during the day and, one ready, placed in the Leavening Retarder equipment and, through programming, leavening is blocked until the time when you want the bread ready to be baked.

An automatic leavening retarder cycle is made up of 5 different phases connected in cascade, with different temperatures, relative humidities and durations.

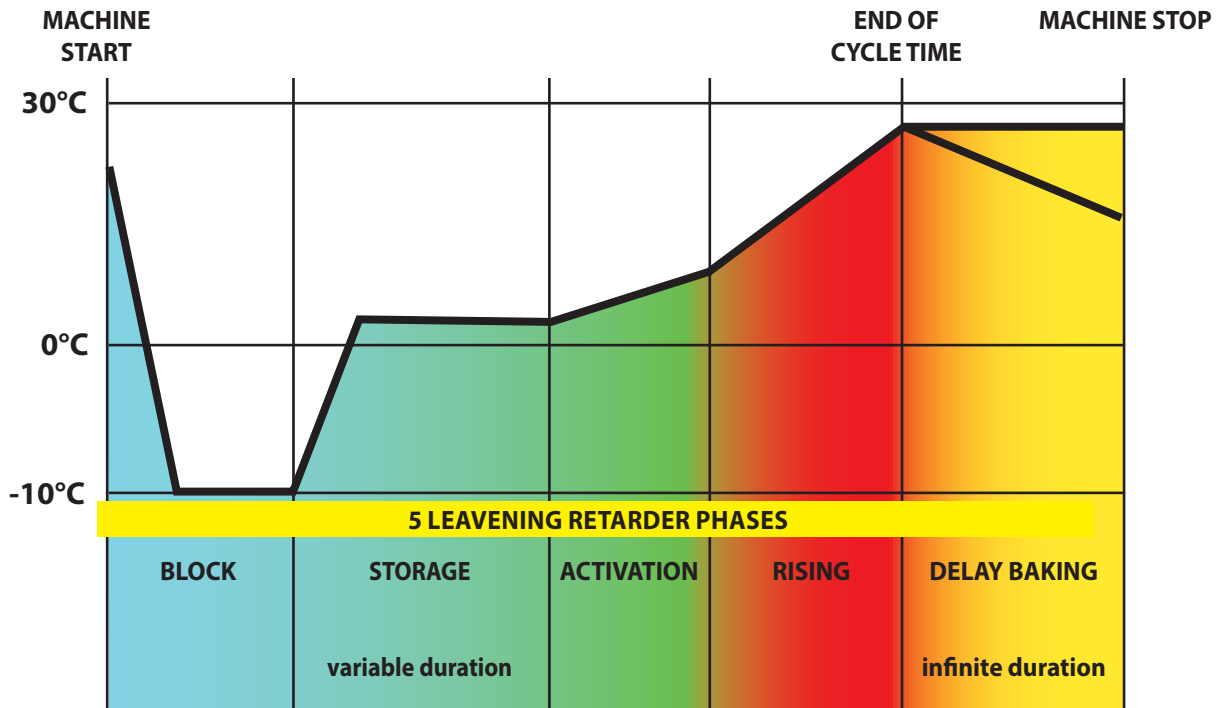

Phase 1: BLOCK

The **block** phase is the first phase in the *Leavening Retarder* cycle. It "blocks" leavens in the prepared dough to delay rising.

Phase 2: STORAGE

The **storage** phase is the second phase in the *Leavening Retarder* cycle.

It keeps the dough at a temperature where it is not frozen but still does not activate leavens, awaiting the activation phase before leavening.

Phase 3: ACTIVATION

The **activation** phase is the third phase in the *Leavening Retarder* cycle.

It raises the temperature in the cell activating dough leavens, thus obtaining pre-leavening.

Phase 4: RISING

The **rising** phase is the fourth phase in the *Leavening Retarder* cycle.

It completes dough leavening to make it ready to be baked on the day and at the time set by the end user.

Phase 5: DELAY BAKING

The **delay baking** phase is the fifth phase in the *Leavening Retarder* cycle.

It is used to keep the dough leavened awaiting baking. The delayed baking phase is always enabled but can be disabled by the user both during the cycle settings phase and with the cycle running (in this case the machine enters stand-by at the end of rising).

Automatic Leavening Retarder

The **automatic leavening retarder** cycle compared to the **manual** one provides a cookbook (series of automatic cycles) divided between fresh and frozen products for each product category.

Times and set values for all phases in each recipe in the cookbook, using **Advanced Mode**, can be edited; once adjusted to need, it can be saved in **My Recipes**, or launched by pressing **START** on the display.

- 1 Select the **Leavening Retarder** cycle from the main screen touching the corresponding icon.
- 2 3 Select the required food icon, specifying whether fresh or frozen.

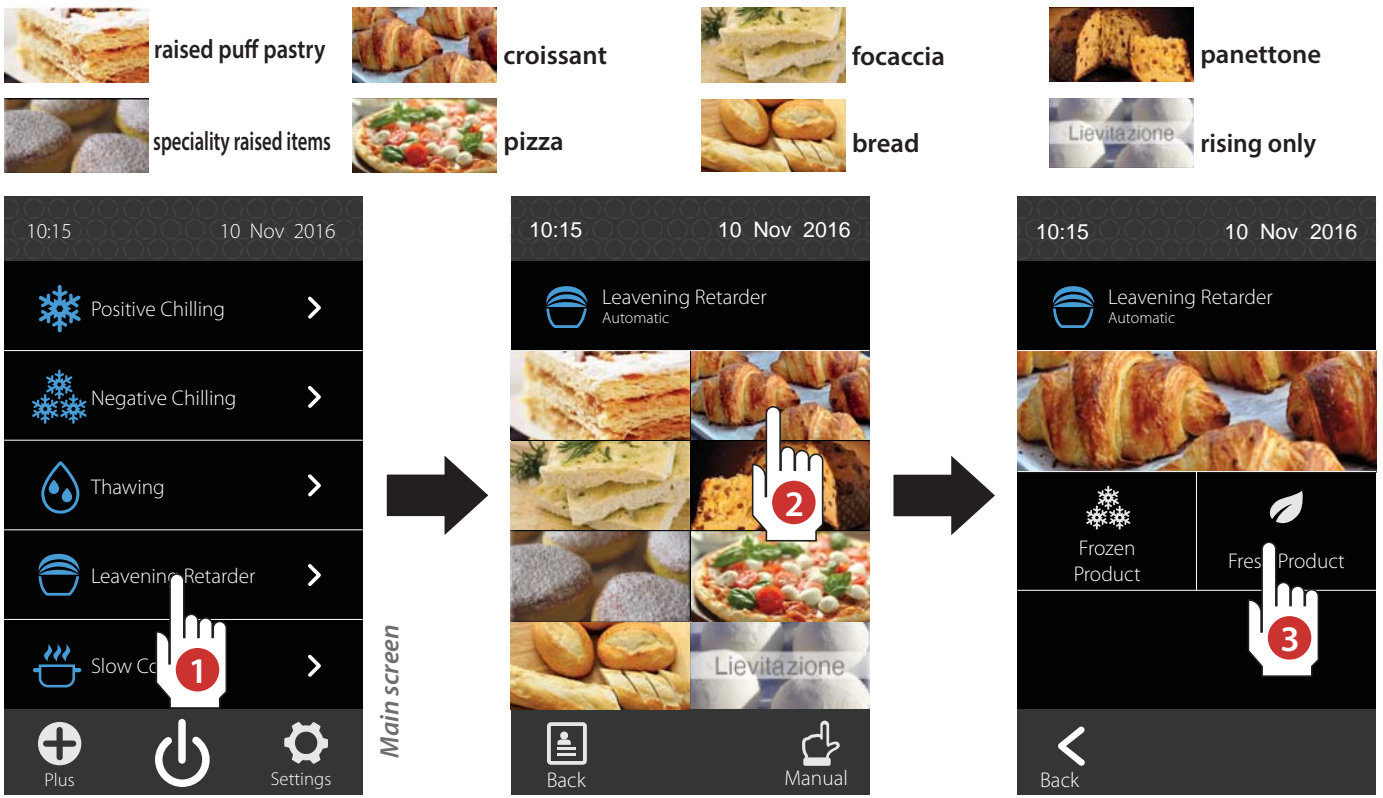

After selecting the recipe, the end of the cycle can be set:

- **A** moving directly 24 or 48 hours from the end time indicated by the clock;
- **B** touch the section with the clock icon and change the end cycle time (**B1** and **B2**);
- **C** touch the **calendar** icon to select the day and time (**C1**, **C2** and **C3**).



LEAVENING RETARDER



- Use the **Delay baking** key to enable/disable Leavening Retarder Phase 5 (*use to keep dough leaven awaiting baking*).
The delayed baking phase can be disabled by the user both during the cycle settings phase and with the cycle running (in this case the machine enters stand-by at the end of rising).
- To start the **Leavening Retarder** cycle, touch **START**, to stop it in advance, touch **STOP**.

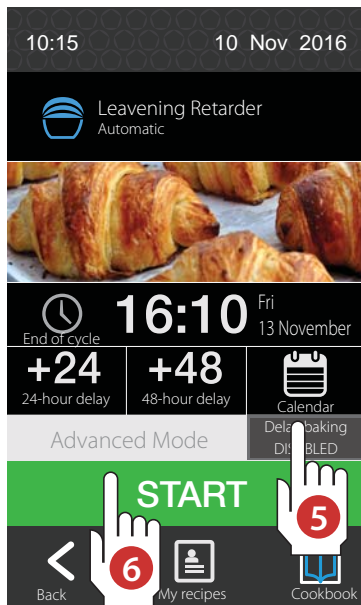

time remaining until the end of the indicated phase

chamber temperature
 - red: heating ON
 - white: compr. and heating OFF
 - blue: compressor ON
 - blinking: compressor waiting for short interval restarts

end of cycle time and date

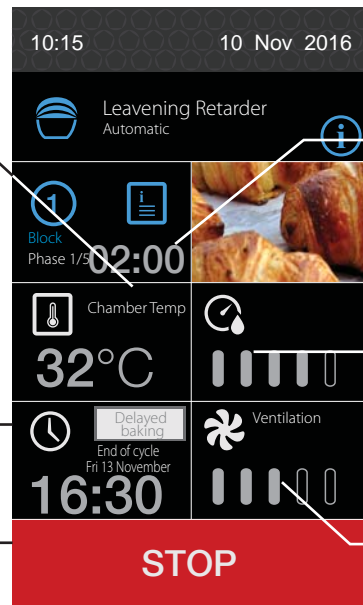





With the cycle started, touch the **info** icon on the display and select one of the 5 phases to check all cycle values although then can no longer be changed.

humidity
 - blue: humidity ON
 - white: humidity OFF
 - empty: humidity not set in the phase

fan speed
 - white: fan ON
 - blue: fan OFF

At the end of the cycle, if **Delay baking** was not enabled, the machine stops, the buzzer sounds, and message "**Cycle completed**" appears and the background changes colour from black to green.

To save the completed cycle:

- Touch .
- 3 4 Enter the recipe name using the keypad ("CIABATTA" in the example), confirm the name with  or clear with  and select the position where the recipe will be saved (position 02 in the example which is the first free position).
- 5 Confirm the selected position with  or cancel with . If the selected position is already occupied by another recipe, a warning to be confirmed appears on the display ("**Overwrite the existing recipe in place 01**").

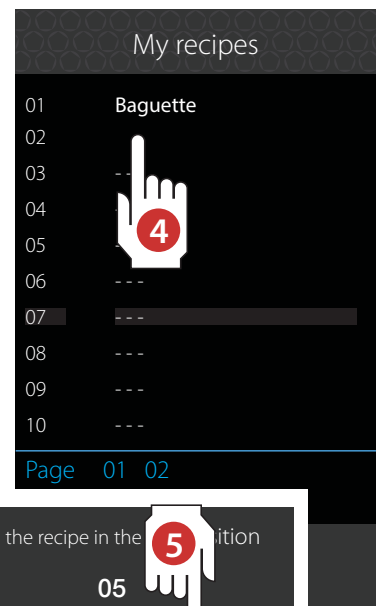
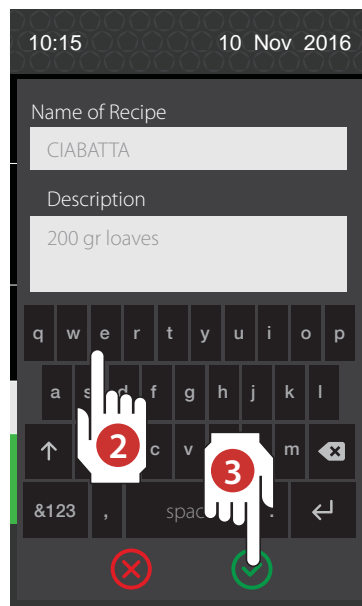
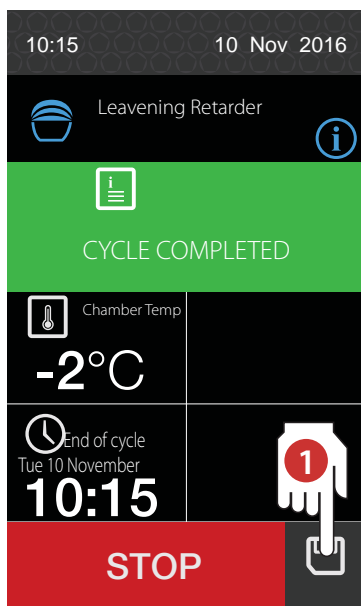



Default values for Leavening Retarder cycles

 RAISED PUFF PASTRY	BLOCK		STORAGE		ACTIVATION		RISING		MAINTENANCE	
	Fresh	Frozen	Fresh	Frozen	Fresh	Frozen	Fresh	Frozen	Fresh	Frozen
Set Cell	-7°C	-18°C	4°C	10°C	12°C	18°C	26°C	28°C	10°C	15°C
Fan speed	2	5	2	5	2	5	2	3	2	2
Set Core	120 min	120 min	---	---	120 min	240 min	180 min	240 min	---	---
Set Humidity	---	---	80%	60%	80%	60%	80%	60%	80%	60%

 CROISSANT	BLOCK		STORAGE		ACTIVATION		RISING		MAINTENANCE	
	Fresh	Frozen	Fresh	Frozen	Fresh	Frozen	Fresh	Frozen	Fresh	Frozen
Set Cell	-4°C	-14°C	6°C	12°C	12°C	18°C	26°C	28°C	10°C	15°C
Fan speed	2	5	2	5	2	5	2	3	2	2
Set Core	120 min	120 min	---	---	120 min	240 min	180 min	240 min	---	---
Set Humidity	---	---	80%	60%	80%	60%	80%	60%	80%	60%

 FOCACCIA	BLOCK		STORAGE		ACTIVATION		RISING		MAINTENANCE	
	Fresh	Frozen	Fresh	Frozen	Fresh	Frozen	Fresh	Frozen	Fresh	Frozen
Set Cell	-4°C	-18°C	7°C	12°C	12°C	18°C	26°C	28°C	10°C	15°C
Fan speed	2	5	2	5	2	5	2	3	2	2
Set Core	180 min	180 min	---	---	180 min	180 min	180 min	240 min	---	---
Set Humidity	---	---	80%	60%	80%	60%	80%	60%	80%	60%

 PANETTONE	BLOCK		STORAGE		ACTIVATION		RISING		MAINTENANCE	
	Fresh	Frozen	Fresh	Frozen	Fresh	Frozen	Fresh	Frozen	Fresh	Frozen
Set Cell	-4°C	-14°C	3°C	7°C	12°C	18°C	26°C	28°C	8°C	10°C
Fan speed	2	5	2	5	2	5	3	5	2	2
Set Core	120 min	240 min	---	---	120 min	240 min	360 min	480 min	---	---
Set Humidity	---	---	80%	60%	80%	60%	80%	60%	80%	60%

 SPECIALITY RAISED ITEMS	BLOCK		STORAGE		ACTIVATION		RISING		MAINTENANCE	
	Fresh	Frozen	Fresh	Frozen	Fresh	Frozen	Fresh	Frozen	Fresh	Frozen
Set Cell	-3°C	-14°C	3°C	7°C	7°C	12°C	26°C	28°C	8°C	10°C
Fan speed	2	5	2	5	3	5	3	5	2	2
Set Core	180 min	360 min	---	---	180 min	360 min	180 min	240 min	---	---
Set Humidity	---	---	80%	60%	80%	60%	80%	60%	80%	60%



 PIZZA	BLOCK		STORAGE		ACTIVATION		RISING		MAINTENANCE	
	Fresh	Frozen	Fresh	Frozen	Fresh	Frozen	Fresh	Frozen	Fresh	Frozen
Set Cell	-3°C	-14°C	3°C	7°C	10°C	14°C	24°C	26°C	8°C	10°C
Fan speed	2	5	2	5	2	5	2	3	2	2
Set Core	180 min	360 min	---	---	180 min	360 min	360 min	480 min	---	---
Set Humidity	---	---	80%	60%	80%	60%	80%	60%	80%	60%

 BREAD	BLOCK		STORAGE		ACTIVATION		RISING		MAINTENANCE	
	Fresh	Frozen	Fresh	Frozen	Fresh	Frozen	Fresh	Frozen	Fresh	Frozen
Set Cell	-3°C	-14°C	3°C	7°C	8°C	10°C	26°C	28°C	8°C	10°C
Fan speed	2	5	2	5	2	5	3	5	2	2
Set Core	180 min	360 min	---	---	180 min	360 min	180 min	240 min	---	---
Set Humidity	---	---	80%	60%	80%	60%	80%	60%	80%	60%

LEAVENING RETARDER



Editing Leavening Retarder cycle parameters (optional)

- 7** To edit the cycle parameters to be launched, touch **Advanced Mode**.
- 8** Touch the Phase to be changed (from 1 to 5 - Phase 3 - **Activation** in the example).
- 9** The user can change:
 - the cell **temperature** during the selected phase;
 - the cell **humidity** during the selected phase;
 - the selected phase **duration**;
 - **fan speed** during the selected phase.
- 10** Save settings with  or clear entered values with .
- 11** Press **Back** to exit settings.
- 12** Press **START** to run the cycle with the newly set parameters.

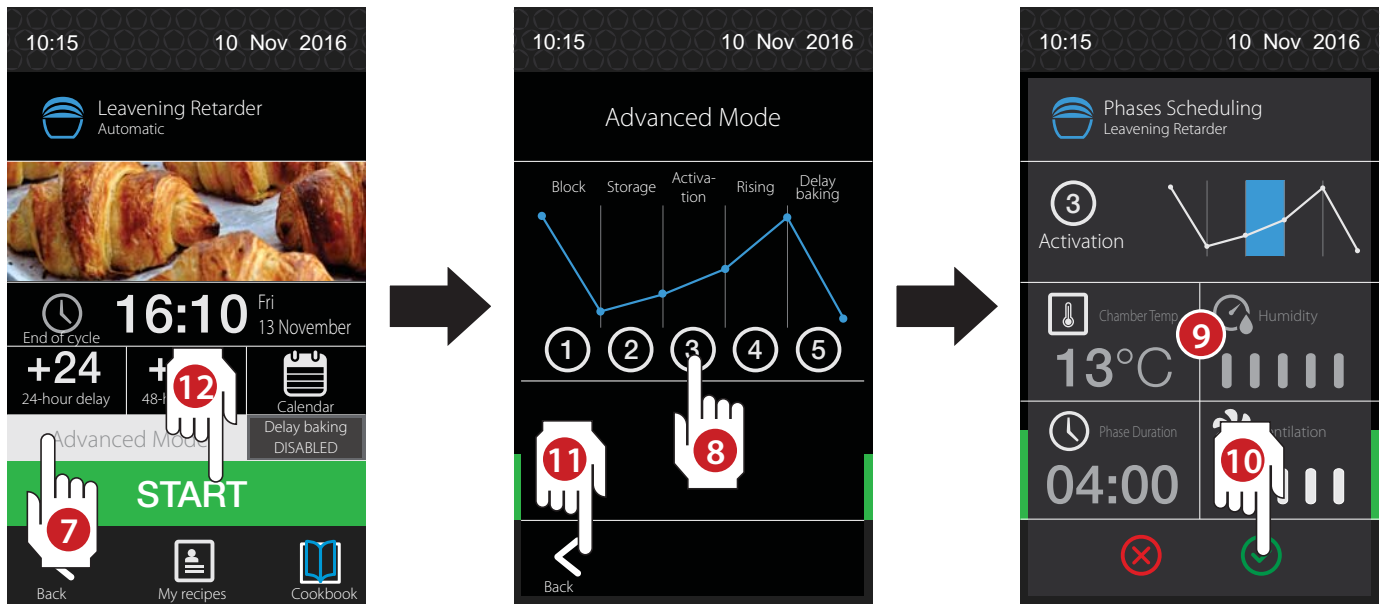

If after starting the cycle by pressing **START**, the sum of all phase durations (**Phase 1** duration + **Phase 2** duration, etc...) is too long compared to the set end of cycle time, the section with the **START** key turns red and blinks, while the time blinks indicating the first useful end cycle time.

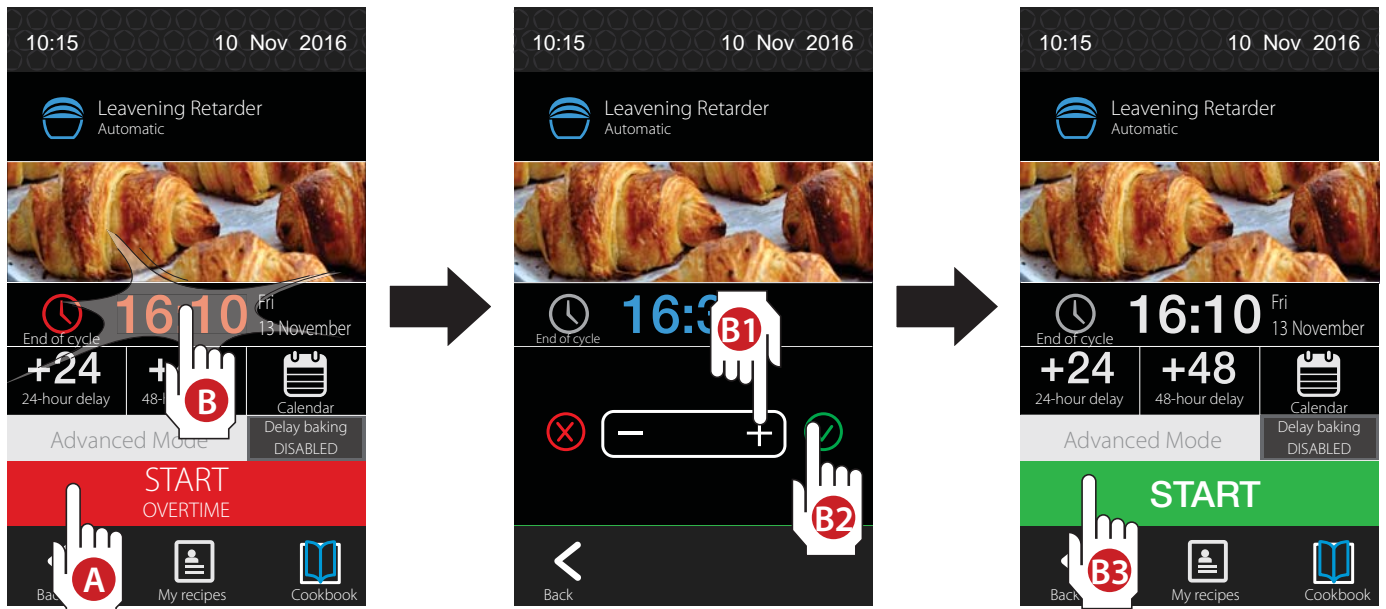

If the proposed time is accepted -> press **START OVERTIME** **A**

If the proposed time is REJECTED -> touch the proposed time **B**, change it as required **B1** and confirm settings with  or clear entered values with  **B2**. Press **START** to start the cycle **B3**.





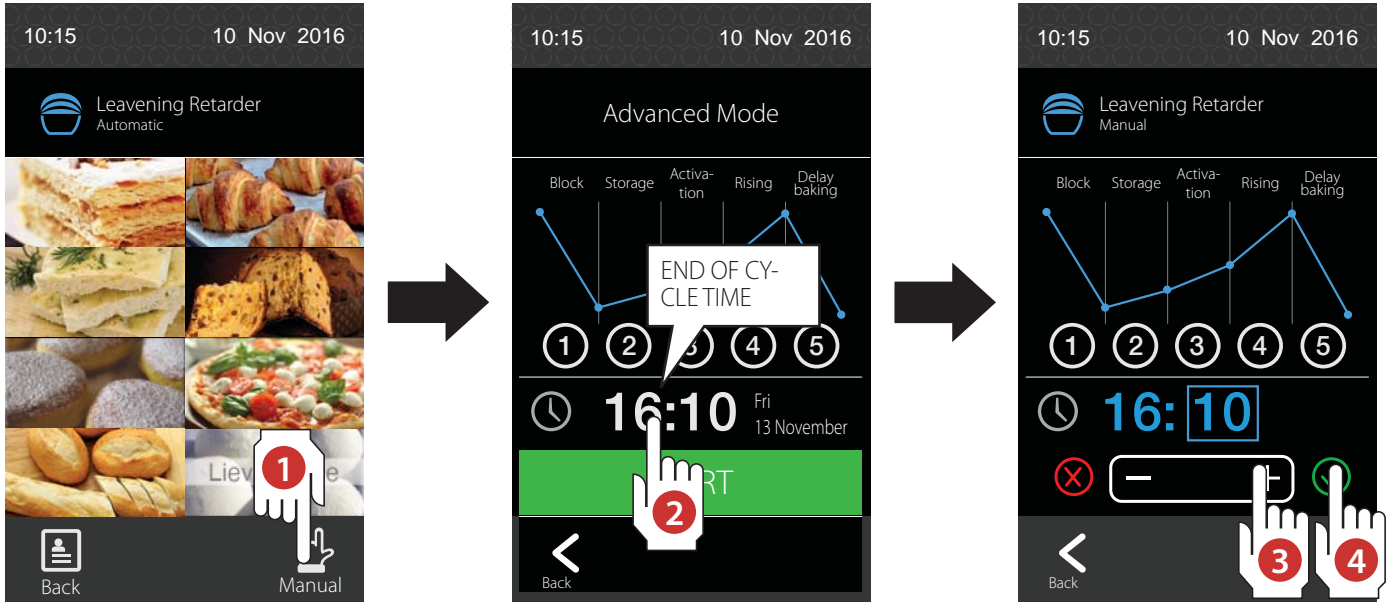

Manual Leavening Retarder

The **manual leavening retarder** cycle, compared to the automatic one, does NOT include the **Cookbook** and **My Recipes** section and is used when a custom leavening retarder cycle is to be immediately started.

- 1 Select the **Leavening Retarder** cycle and press **Manual** touching the corresponding icon.
- 2 3 4 Touch the time to set the end of cycle time and confirm with  or cancel with .



- 5 6 7 Touch the date to set the end of cycle day and confirm with  or cancel with .
- 8 9 10 Touch one of the 5 phases to set set points: initially the settings are grey (in the example on the following page, 13°C), blue when programming and white once set.
- 11 Confirm with  or cancel with .

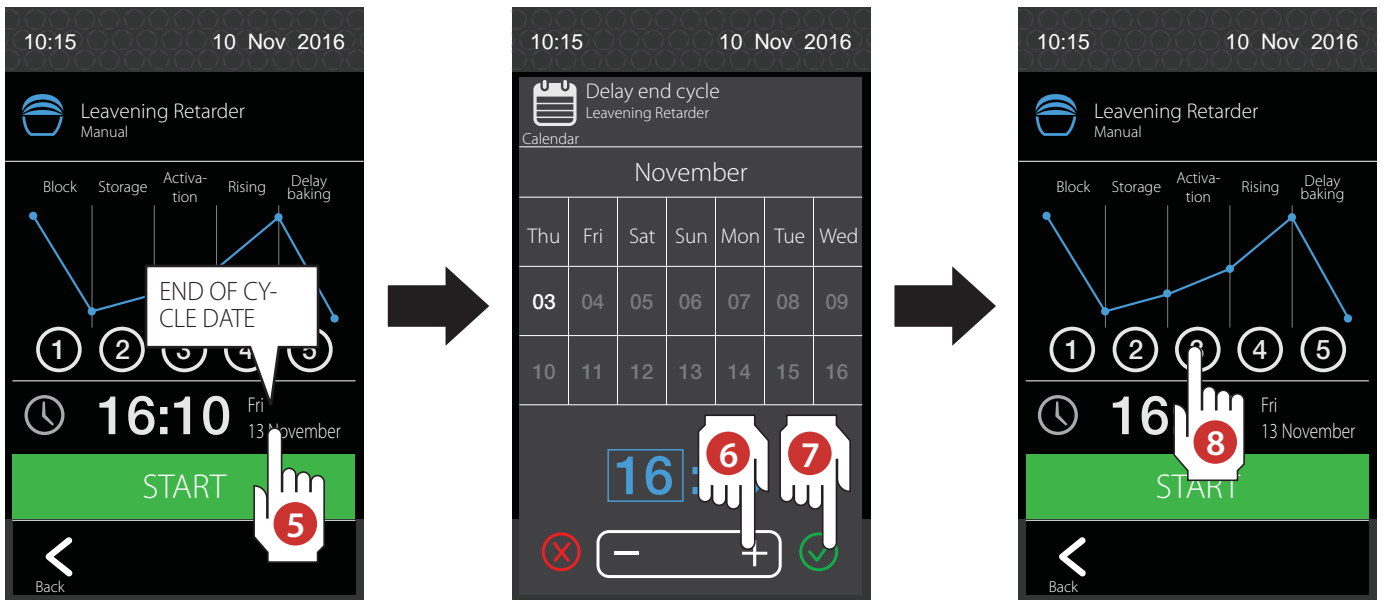

LEAVENING RETARDER



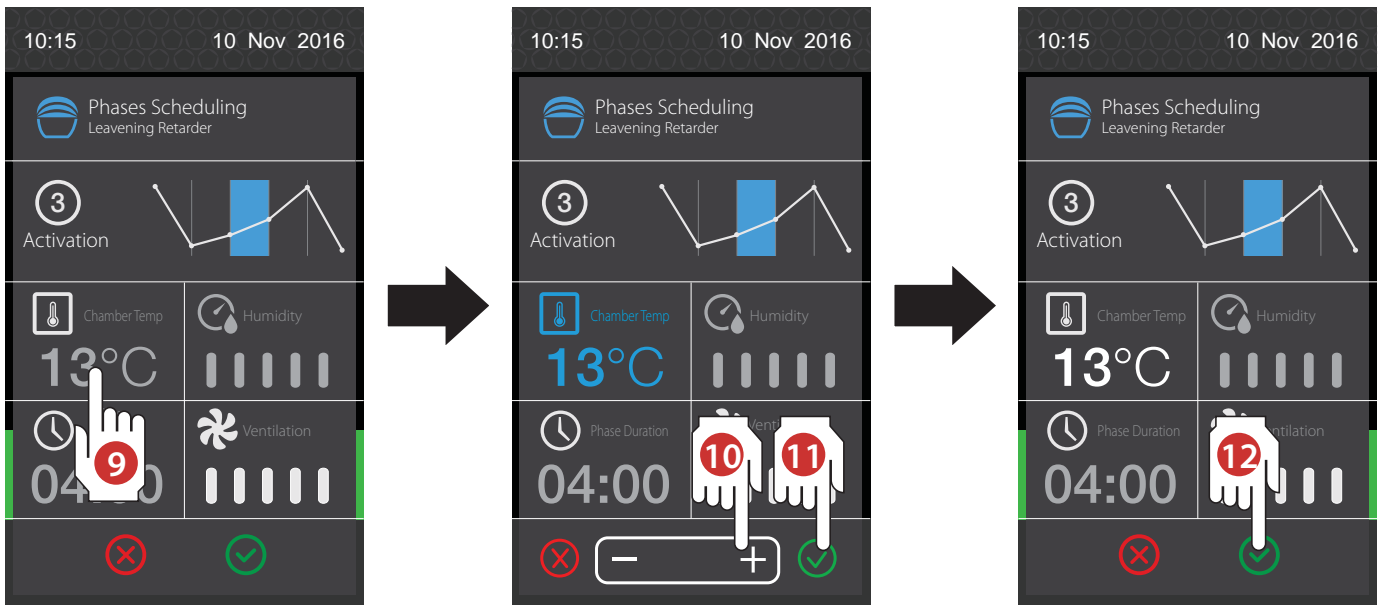



12 After confirming changes with icon , the **START** key appears to start the cycle.

13 To start the **Leavening Retarder** cycle, touch **START**, to stop it in advance, touch **STOP**.

If after starting the cycle by pressing **START**, the sum of all phase durations (**Phase 1** duration + **Phase 2** duration, etc...) is too long compared to the set end of cycle time, the section with the **START** key turns red and blinks, while the time blinks indicating the first useful end cycle time.

If the proposed time is accepted -> press **START OVERTIME** **A**

If the proposed time is REJECTED -> touch the proposed time **B**, change it as required **B1** and confirm settings with  or clear entered values with  **B2**. Press **START** to start the cycle **B3**.



WHY HUMIDIFY AND HOW MUCH

Humidification keeps leavening dough surfaces elastic and humid, avoiding the formation of a crust that could hinder bread rising. Sweet doughs, since containing sugars and fats, are less effected by this problem, requiring lower percentages of humidity than savoury doughs.

time remaining until the end of the indicated phase

chamber temperature
 - red: heating ON
 - white: compr. and heating OFF
 - blue: compressor ON
 - blinking: compressor waiting for short interval restarts

end of cycle time and date

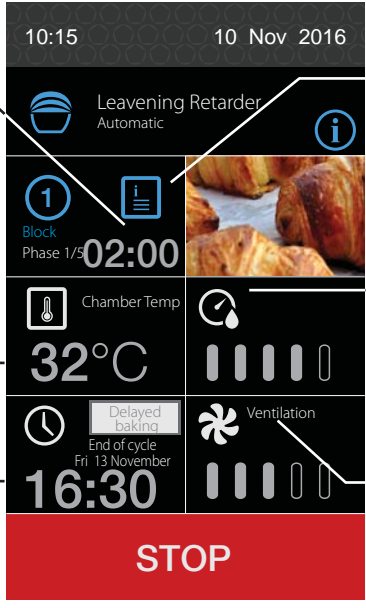

With the cycle started, touch the info icon on the display and select one of the 5 phases to check all cycle values although then can no longer be changed.

humidity
 - blue: humidity ON
 - white: humidity OFF
 - empty: humidity not set in the phase

fan speed
 - white: fan ON
 - blue: fan OFF

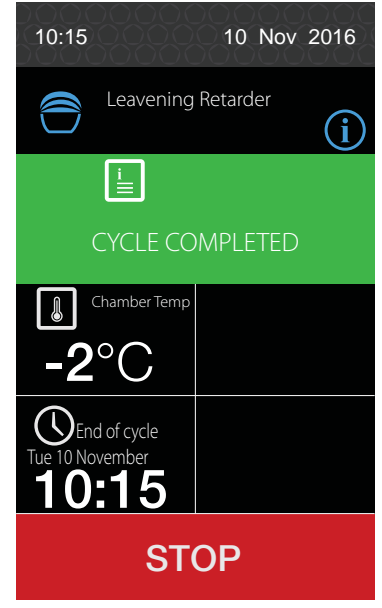

At the end of the cycle, if **Delay baking** was not enabled, the machine stops, the buzzer sounds, and message **“Cycle completed”** appears and the background changes colour from black to green.
 Manual **Leavening Retarder** cycles cannot be saved since they do not belong to any recipe category.



THE HISTORY OF BREAD

The first time bread appeared: the prehistoric age

Archaeologists have found cereal grains in various prehistoric sites: it is believed that bread was normally used as a supplement food for meat and that the first stable cereal cultivations date back to the neolithic era. Grain was crushed between two rocks and mixed with water to prepare a simple yet extremely nutritious and always available food.

Populations in the Mediterranean basin: the discovery of yeast

The Egyptians were the first population to cultivate cereal on a large scale: lands around the Nile, thanks to lime, were, in fact, very fertile and thus suited for cereal plantations, especially wheat.
 Later, the cultivations extended to the entire Mediterranean basin that has a particularly favourable climate.
 Initially, the grain was crushed in a mortar, then, with a sieve, the nutritious parts of the grain were separated from the external case. This flour was mixed with water and cooked on stones or in containers inside holes made in the ground and heated. In a later period, the first clay conic ovens appears: the fire burnt in the lower part while bread was baked in the upper part.
 The initial water and flour dough, very simple, was soon accompanied by oil, milk, herbs, wine and honey and yeast appeared; in ancient times, two types of yeast were mainly used, one made with millet mixed with sweet wine and left to ferment, the other with wheat bran left to steep for three days in sweet wine and then left to dry in the sun.

The great famines in the Middle Ages

It was not easy to find flour, and thus bread, in the ninth and tenth centuries since the fields were abandoned during the barbarian invasions and harvests could not sufficiently feed the population.
 Bread was thus made with little flour and a lot of bran and often less refined cereals were used like millet, acorn or lubidol flour, elm leaves.
 In the Middle Ages, the most popular grain milling system was costly watermills managed by expert millers and bakers. The baker had to produce and deliver well-baked and leavened bread or was fined.

Until today

Still now, especially in temperate areas, wheat is the most widely cultivated and used cereal in the world for human nutrition. The main producers are China and Canada. European Union countries, especially France, have a total production of 15% of world production.

LEAVENING RETARDER



Manual Rising

This function was created to provide an immediate and simple program, rising only, and lets you set the **Chamber temperature**, **Time**, **Fan speed** and **Humidity** even for the storage phase.

- 1 2** Select the **Leavening Retarder** function and then **Rising**.
- 3** Touch the **Advanced Mode** key to change the settings for the cycle to be run.



- 4** In the **Advanced Mode** screen, the Rising cycle set point can be changed: the duration, fan speed and humidity to be added to the chamber.

The cycle is made up of rising following by custom storage.

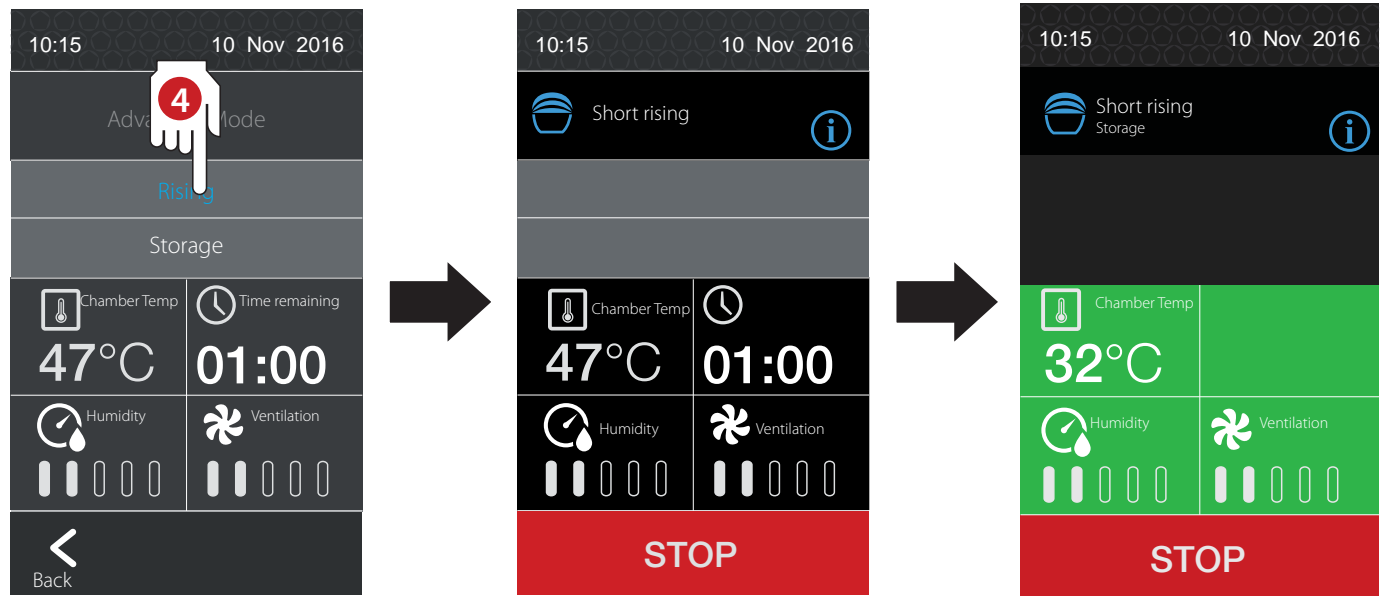

Cooking only
page 43

Cooking + Chilling
page 46

The equipment provides:
 - 3 **Cooking only** cycles with automatic switch to storage temperature (settable);
 - 3 **Cooking+Chilling** cycles with automatic switch to positive or negative chilling.
 The **Cooking only** cycles are recognised since they have a red coloured band over the image, while the **Cooking + Chilling** cycles have a blue band over the image
 All cooking or Cooking + Chilling cycles can be changed and adjusted to cook, using **Advanced Mode**.
 Humidity can be added to the cell in all cycles, settable to 5 levels of intensity.

Cooking only

- 1 2** Select **Slow Cooking** and select a recipe for either meat, fish or cream (**Cooking only** function with red band over the image).
- 3** After selecting the recipe, select whether to **Cook with needle probe** (cooking ends when the set temperature is reached at the core and then the machine automatically switches to storage) or **Timed** (cooking ends after the set time elapses and then automatically switches to storage).
- 4** To start the **Slow Cooking** cycle, touch **START**, to stop it in advance, touch **STOP**.
At the end of cooking, the machine automatically switches to the set storage temperature.

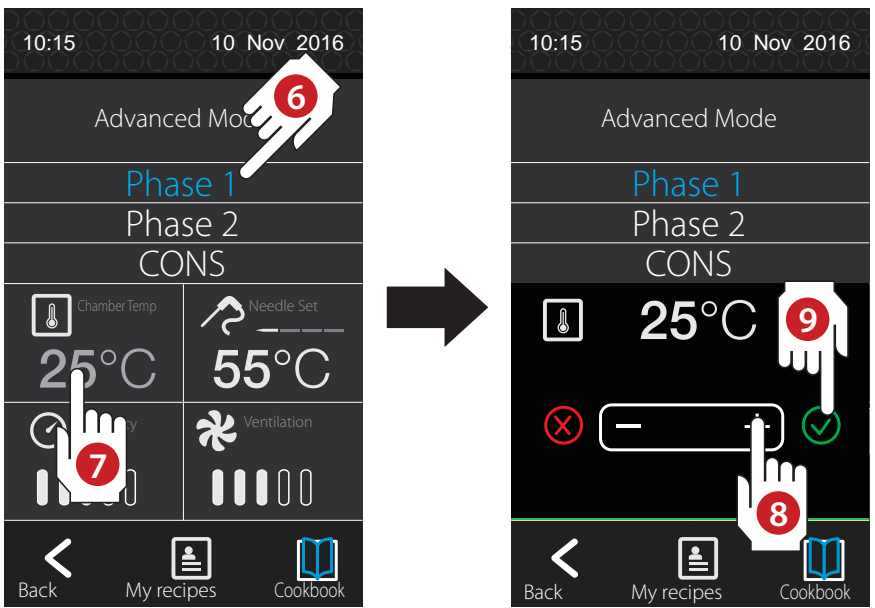
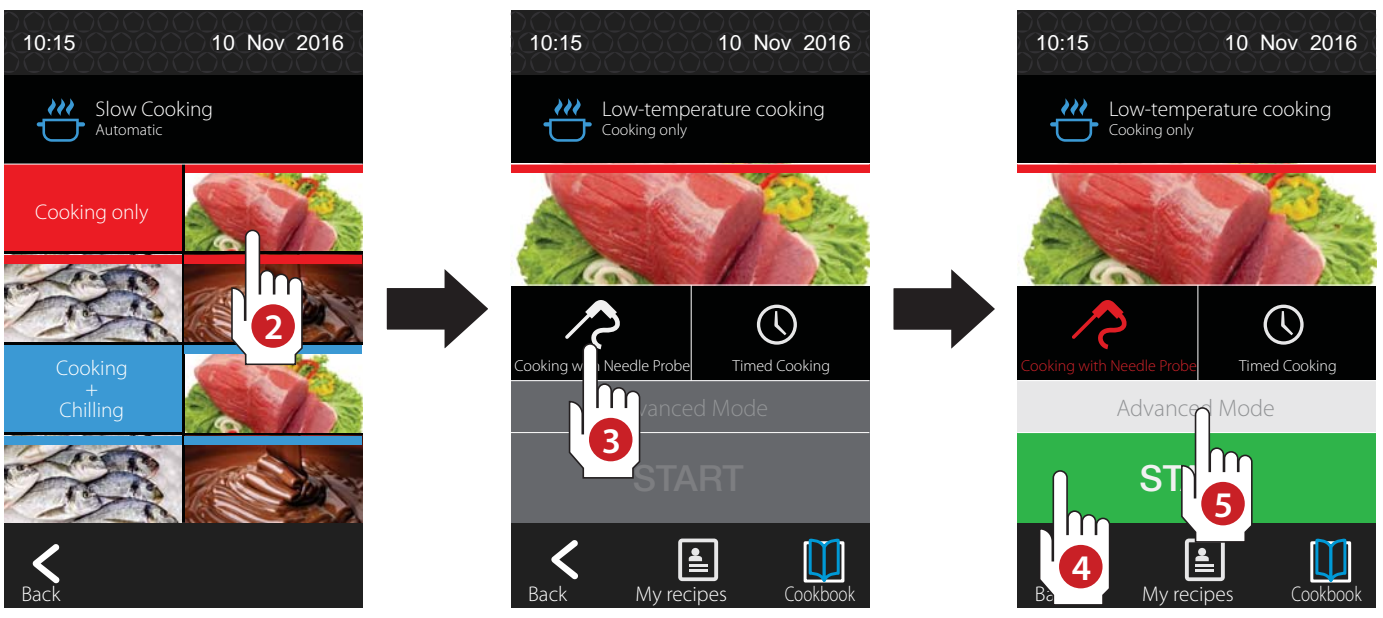

- 5** Before starting the cooking cycle by pressing **START** default settings can be changed for both **Cooking with needle probe** and **Timed**, by opening **Advanced Mode**.
- 6 7 8** Each cooking cycle includes 3 phases, two cooking (Phase 1 and Phase 2) and a storage phase (CONS): for each of these, touch the concerned phase, set the chamber temperature, humidity, fan speed and duration/needle probe temp. (for Cooking phases only). If Phase 2 is not required, simply set its temperature equal to that in PHASE 1.
- 9** After setting the required values, confirm with or clear entered values with .

SLOW COOKING

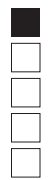

10 11 To run the cycle, press **Back** and then **START**.



Cooking with needle probe progress after pressing **START**:

- > **PHASE1**;
- > **PHASE2** (when the temperature set in **PHASE 1** is reached in the core);
- > end cooking (when the temperature set in **PHASE 2** is reached in the core);
- > automatic switch to **Storage phase**.

Timed cooking progress after pressing **START**:

- > **PHASE1**;
- > **PHASE2** (at the end of the time set in **PHASE 1**);
- > end of cooking (at the end of the time set in **PHASE 2**);
- > automatic switch to **the storage phase**.



THE various parameters can be viewed or edited (Chamber temp., Needle probe temp., etc-) even when the cooking cycle is running, by touching the corresponding icon.

Using saved recipes

- 1 2** Select **Slow Cooking** and select a recipe for either meat, fish or chocolate (**Cooking only** function with red band over the image).
- 3** After selecting the product category, touch the **Cookbook** icon: various factory set recipes are display, all dedicated to the selected product category ("MEAT" in the example).
- 4 5** Touch the name of the recipe you want, for example "TURKEY BREAST" and press **START** to start the recipe.

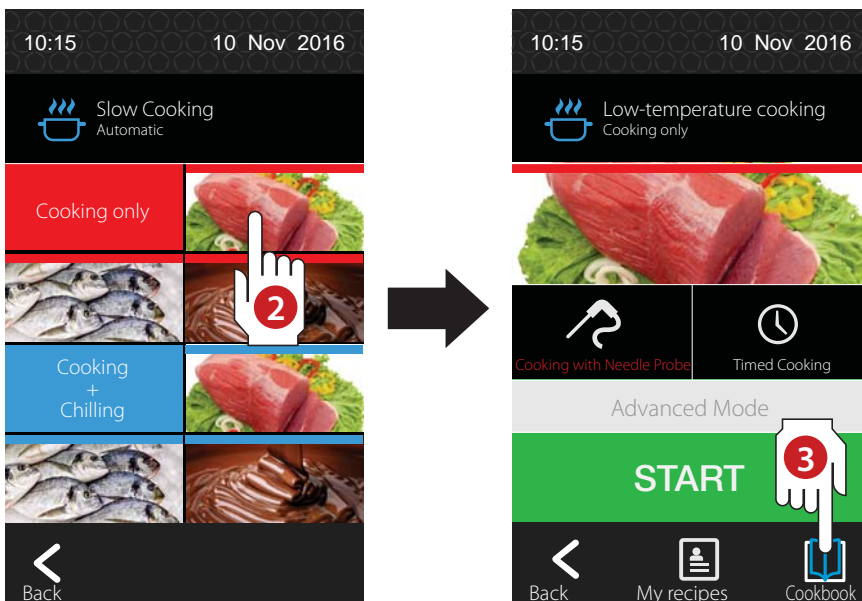



Default cycles dedicated to the "MEAT" family.

The symbols before the recipe name indicate:

cooking ends at the end of the set time, thus the probe need not be inserted in the core of the food to be chilled

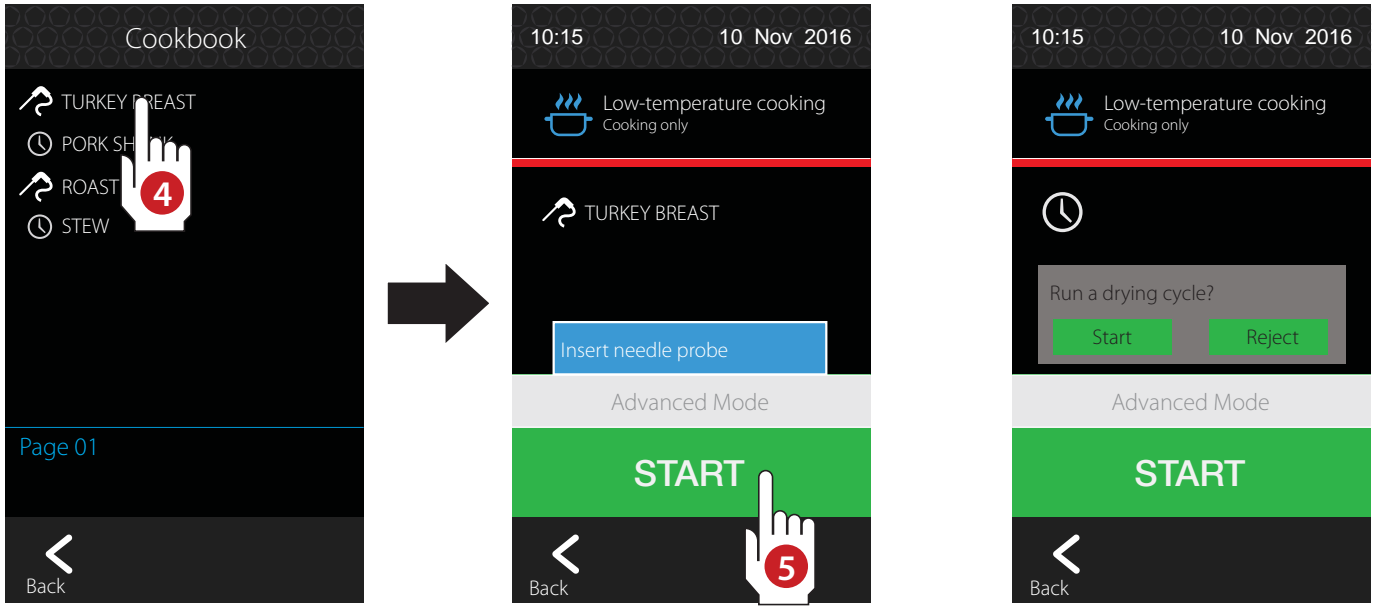
cooking ends when the set core temperature is reached, thus the probe must be inserted in the core of the food to be chilled.



 The drying cycle is recommended before slow cooking that requires a dry environment and is essential for delicate pastry product cooking (e.g. meringues). In some recipes like this, before starting the cycle, drying is automatically requested which can be accepted (**Start**) or rejected (**Reject**).

Creating personal recipes

 See page 15 . Warning, the examples you find in this chapter refer to a chilling cycle but the recipe creating and saving procedures in My recipes is the same for all functions in the machine (Positive Chilling, Negative and Slow Cooking).

NOTES



Cooking + Chilling

- 1 2** Select **Slow Cooking** and select a recipe for either meat, fish or chocolate (**Cooking + Chilling** function with blue band over the image).
- 3** Select cooking with needle probe or timed: if cooking with a needle probe cycle, even chilling, after cooking, it will occur with cycle and needle probe inserted (automatic); if cooking is timed without needle probe, even chilling after cooking will be timed (manual).
- 4 5 6 7 8** If necessary, open **Advanced Mode** to edit cooking set points.

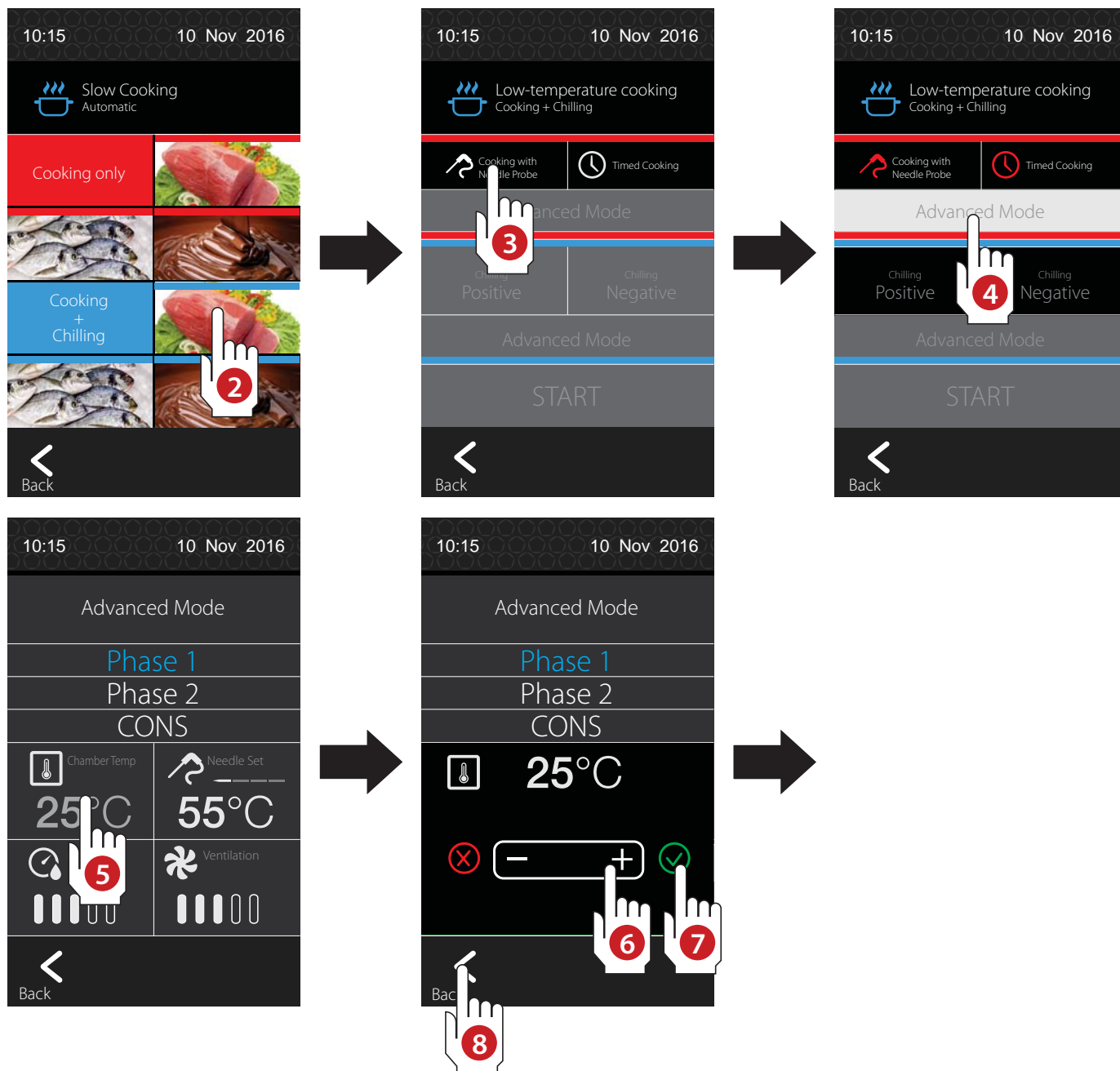

- 9 Select whether, at the end of cooking, **Positive Chilling (+3°C)** or **Negative Chilling (-18°C)** is run
- 10 11 12 13 14 If necessary, open **Advanced Mode** to edit chilling set points.
- 15 Touch **START** to start the **Cooking + Chilling** cycle.

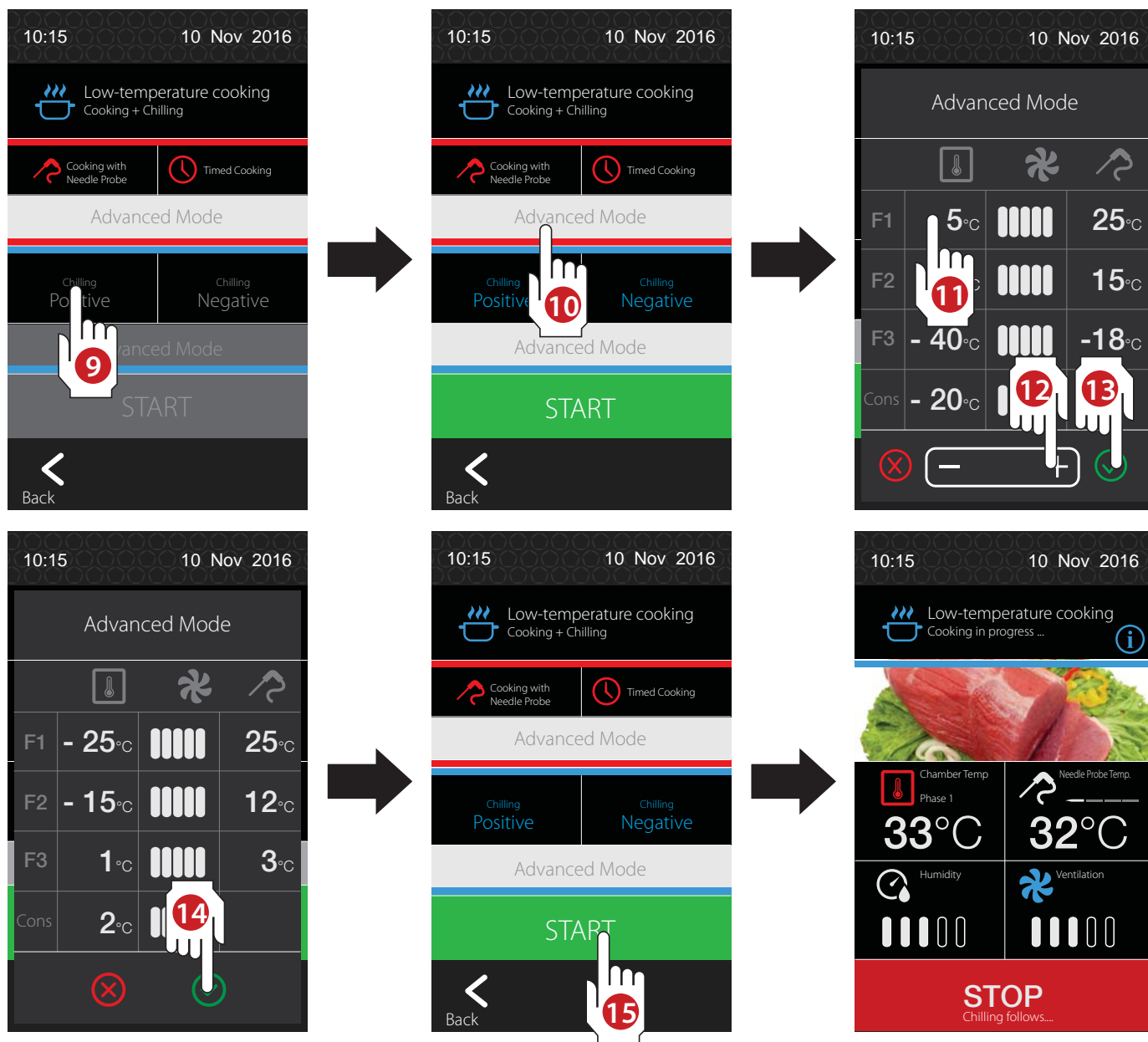

SLOW COOKING

Time and temperature values can be viewed and changed during **Cooking** and **Chilling** as explained in the previous pages.

At the end of chilling, the machine automatically switches to storage. The cycle ends when **STOP** is entered.



COOKBOOK

The **Cookbook** contains default factory recipes, specifically created for each function category and selected family:

FUNCTION CATEGORY	FAMILY
Positive Chilling	meat*, fish*, vegetables*, first courses*, croissant, bread, cakes, creams
Negative Chilling	meat*, fish*, vegetables*, bread, croissant, ice cream, first courses*, cakes**, fruit**
Leavening Retarder	raised puff pastry, croissant, focaccia, panettone, speciality raised items, pizza, bread
Slow Cooking	meat, fish, chocolate
Thawing	The thawing function does not include a cookbook but only default cycles.

To open the recipes, from the main screen, select on of the functions listed above (**Positive Chilling was selected in the example**), based on the picture, select the family (MEAT was selected in the example) and touch the **Recipe** icon. Select the recipe and run it by pressing **START**.

-  Recipes in the **Cookbook** section CANNOT be deleted or PERMANENTLY changed. There settings can only be edited for the cycle to be run (changes are not permanent and are cleared when exiting the program). Settings can only be change before starting the cycle and not when running. Alternatively, the recipe changed by the user can be saved with another name (e.g. "RABBIT ROAST WITH POTATOES") and will be saved under **My recipes**.

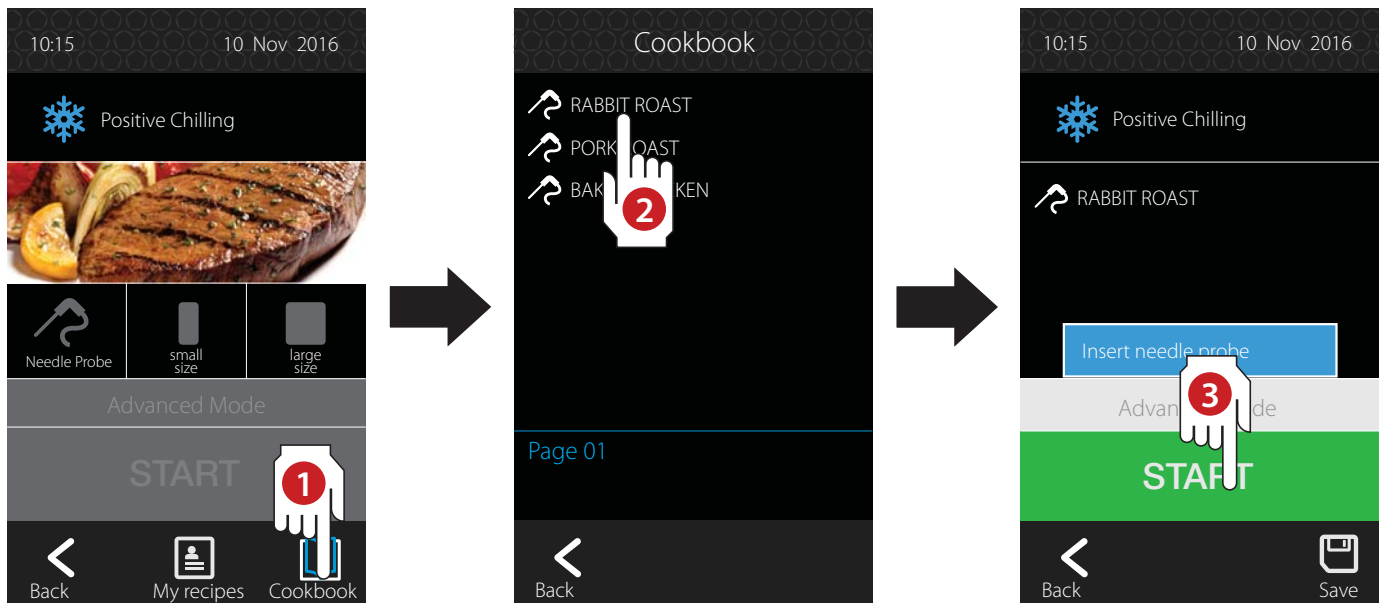

NOTES

MY RECIPES

1 2 To recall one of the previously saved recipes, select the function category (**Positive Chilling**, **Negative Chilling**, etc.), the family (meat, fish, vegetables, etc.) and touch the **My Recipes** icon on the display; at this point only the recipes in the same family will be displayed (e.g. "MEAT").

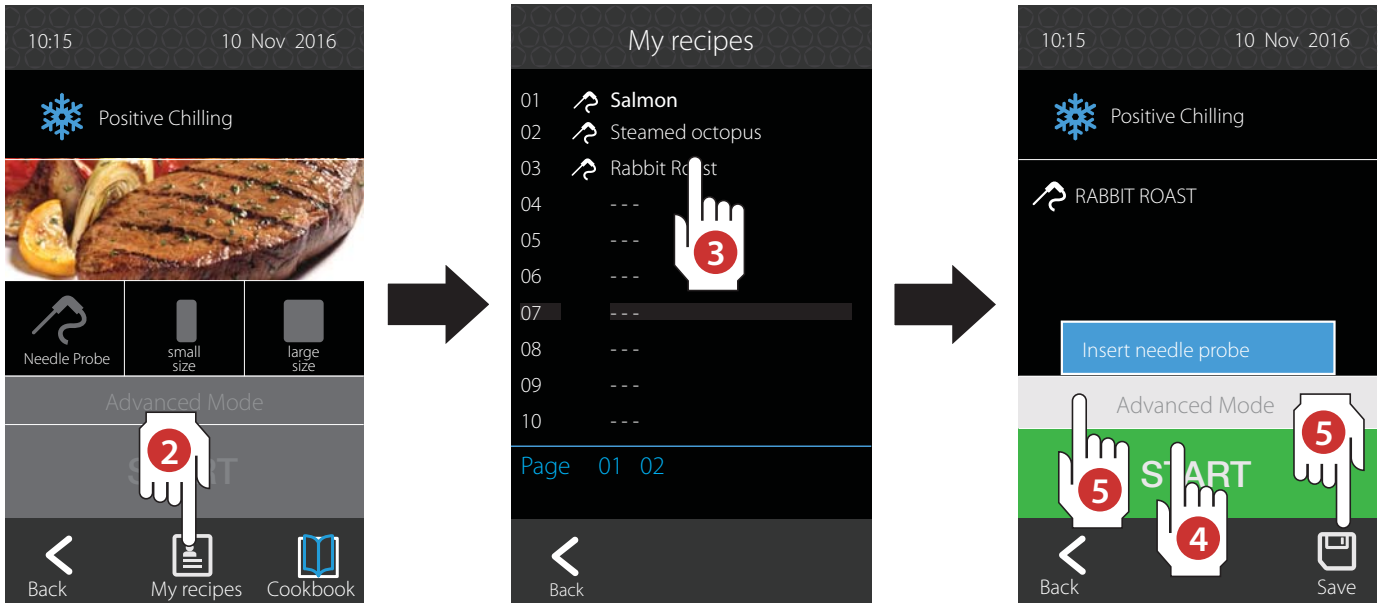



3 4 5 Once the recipe is selected, the cycle can be immediately started by touching **START**, or set points can be edited in **Advanced Mode** and the changed recipe saved by touching the **Save** icon on the display.

 All recipes in **My Recipes** that were saved in the storage phase AFTER A **Positive or Negative Chilling** cycle, automatic or manual, was run, the needle probe need not be inserted in the product core since in this mode the cycle reproduces a recording of cycle times and temperatures run and saved and will have the clock symbol in front of the name. At the end of the third phase, the machine automatically switches to storage.

display.

 All recipes in **My Recipes** that were saved AFTER A **Slow Cooking** cycle, can be **Automatic** if run in Needle Probe mode, **Timed** (manual) if run in timed cooking mode.

 All recipes in **My Recipes** have a needle probe or  clock  symbol before the name to indicate whether they are automatic cycles (with needle probe to be inserted) or manual cycles (timed without the need to insert the needle probe) respectively. These cycles can be created by editing a recipe in the **Cookbook** or saving the cycle by touching the **Save** icon in the storage phase in progress.

Creating a recipe

 See page 15. Warning, the examples you find in this chapter refer to a chilling cycle but the recipe creating and saving procedures in **My recipes** is the same for all functions in the machine (**Positive Chilling**, **Negative** and **Slow Cooking**).

NEEDLE PROBE HEATING

- To facilitate needle probe removal from the product after a negative chilling cycle, select **Plus** at the bottom left of the main screen and then needle heating to start the cycle.

The Needle Probe can only be Heated if its temperature is under -5°C.

The heating phase automatically stops after the temperature suited to remove the needle probe from the product is reached and the "remove needle probe" message appears on the screen. Touch the message to exit.

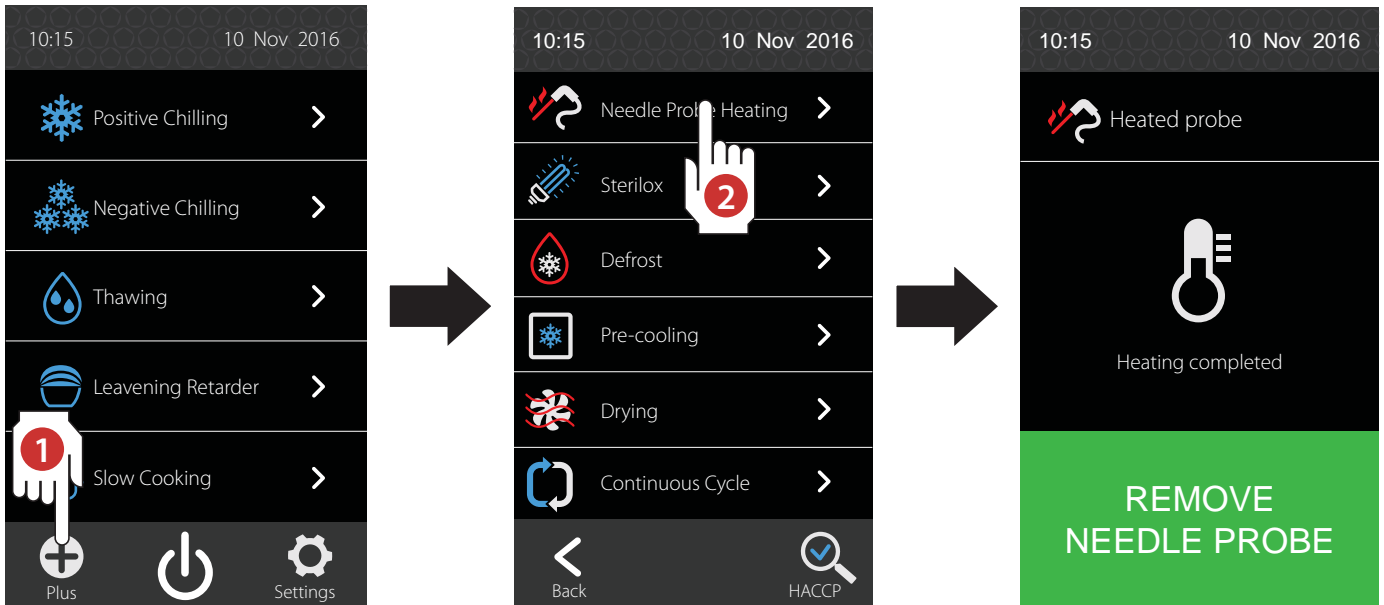

STERILOX (OPTIONAL)

Touch the Sterilox icon to start the sterilisation cycle:

Sterilisation can only start if the chamber temperature is over 15°C and with the door closed.

Sterilisation ends:

- at the end of the set time
- by pressing **STOP**.
- opening the door.

The time remaining until the end of sterilisation is displayed.

When finished, message "**Cycle completed**" appears. Touch the message to exit.

Opening a door or a blackout interrupt sterilisation.

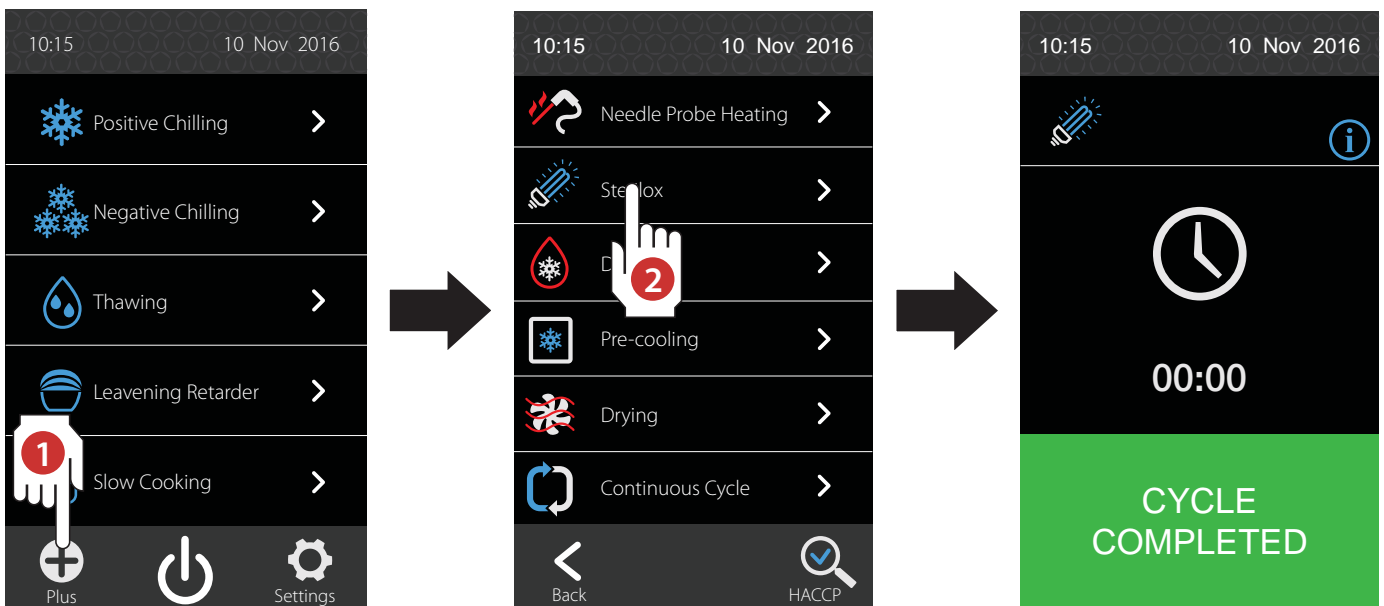

HOT GAS DEFROST

To activate defrost, touch **Defrost**, the cycle immediately starts.

Defrosting automatically starts in all storage cycles, with the product inserted; after defrosting, the machine returns to normal operations.

Defrosting can only start if the evaporator temperature is under 3°C.

Defrost ends:

- when the end defrost temperature is reached. (Message "**Cycle completed**" appears)
- by pressing **STOP** (message "**Cycle interrupted**" appears)



PRE-COOLING

Before starting a **Positive Chilling +3°C** cycle or **Negative Chilling -18°C** cycle, the cell should be pre-cooled before introducing food.

To start the function, follow points **1** and **2** in the illustration below: a cycle immediately starts that brings chamber temperature to -25°C (with the cycle started the descending chamber temperature is displayed).

Once his temperature is reached, a buzzer sounds for 3 seconds every 60 seconds to indicate that the equipment is ready for food to be chilled and to run a **Positive chilling +3°C** or **Negative chilling -18°C** cycle.

To stop pre-cooling in advance, open the door or touch the **STOP** key.

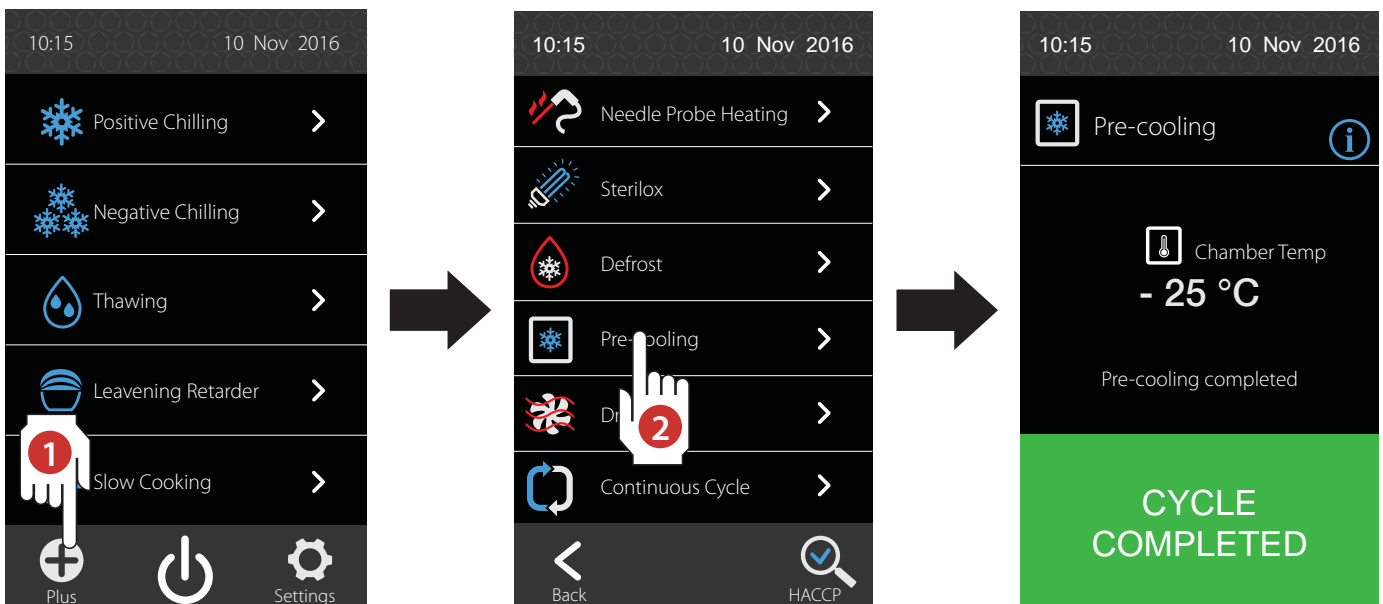

DRYING

The drying cycle is recommended before slow cooking that requires a dry environment and is essential for delicate pastry product cooking (e.g. meringues). In some recipes like this, before starting the cycle, drying is automatically requested.

Function use is also helpful after cell interior cleaning and rinsing at the end of the work day with shower to fully dry the interior.

End of cycle indications are:

- cycle completed at the end of the drying cycle;
- cycle interrupted if the **STOP** key was pressed in advance to end the drying function;
- Touch message **"Cycle completed"** or **"Cycle interrupted"** to exit.

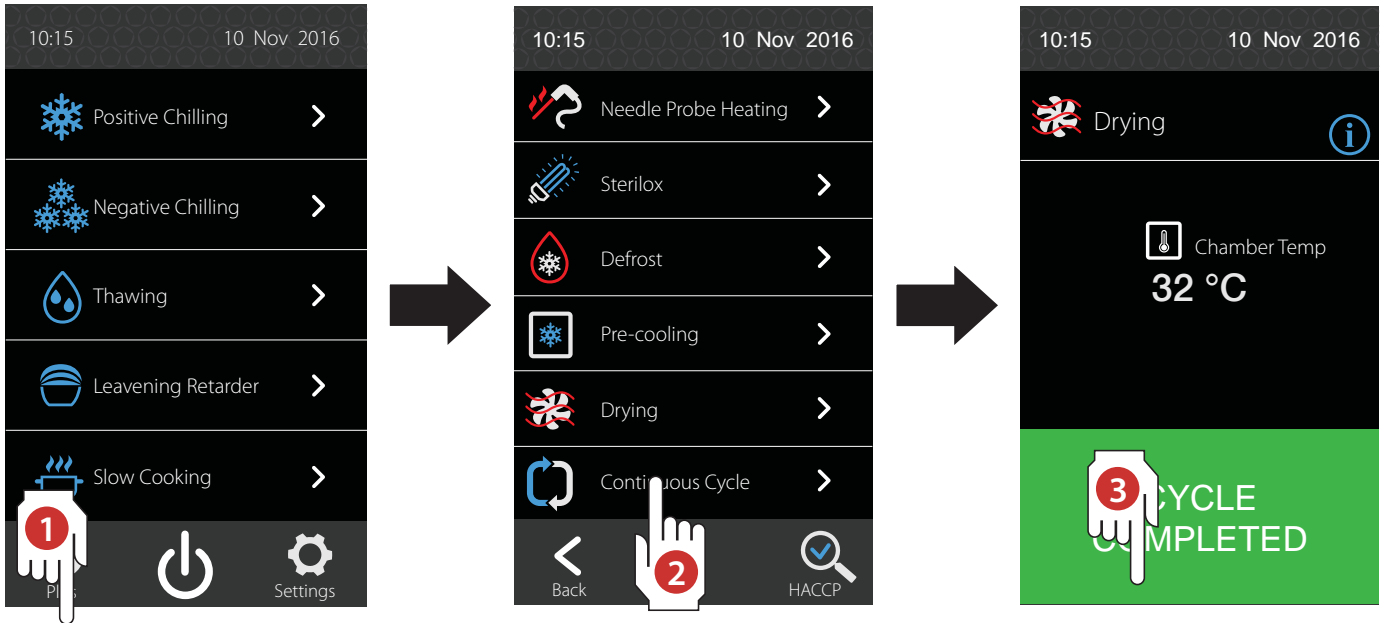

CONTINUOUS CYCLE

This function lets you quickly set the temperature and air speed for a **Continuous Cycle** that only ends when the **STOP** key is pressed. Furthermore, after start, touch **Multi level** on the display to activate up to 8 timers to be assigned to each time interval in the cell.

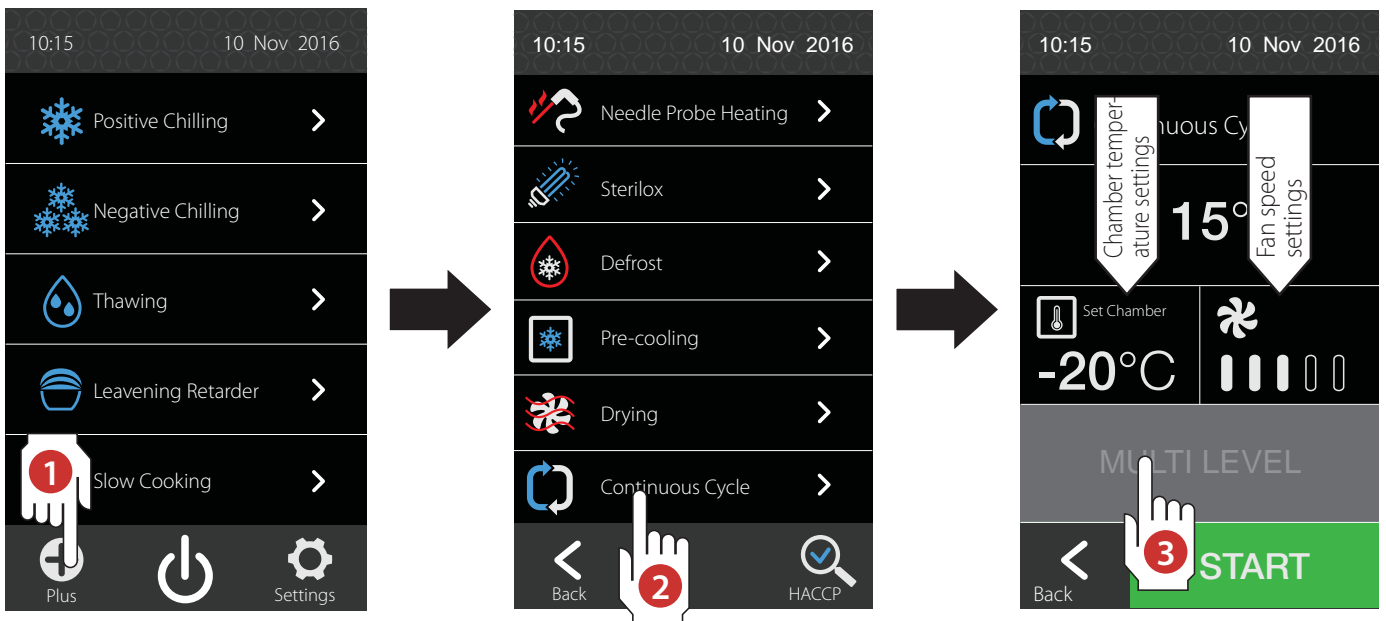

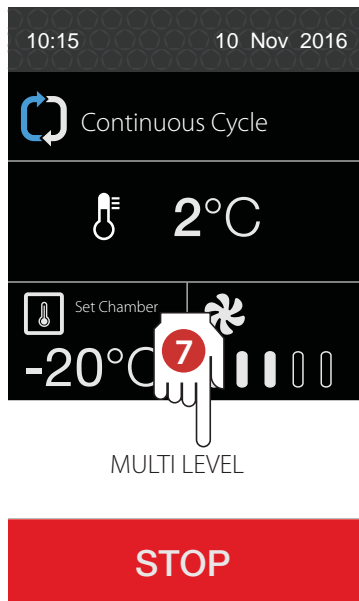
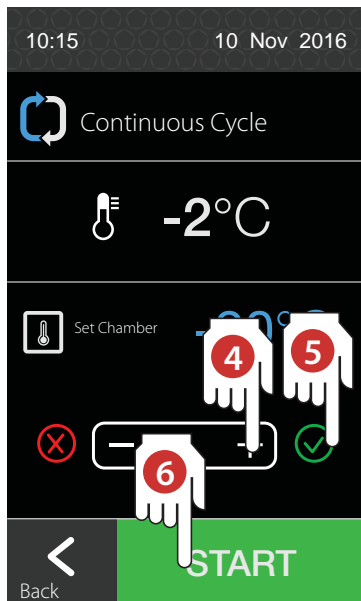

7 Press **Multi level** to open the screen with the timers where you can set up to a maximum of 8 timers simultaneously.

8 9 Press the required timer to change the time that turns blue

10 Press the key to start the timer and start the countdown: at the end of the countdown message **END** appears in green. Open the door or touch the time to return the countdown to " --- " (no time set). If a timer ends with the initial **Continuous Cycle** screen, the machine automatically switches to **Multi level** mode that indicates the expired timer.

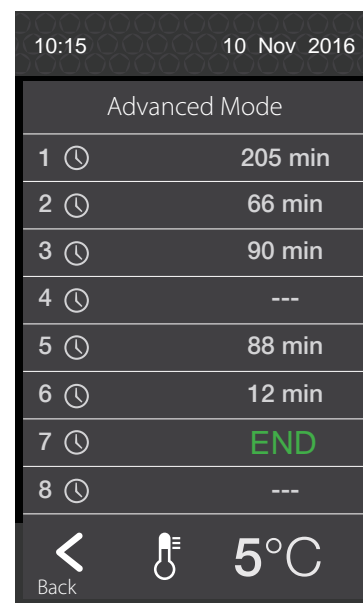
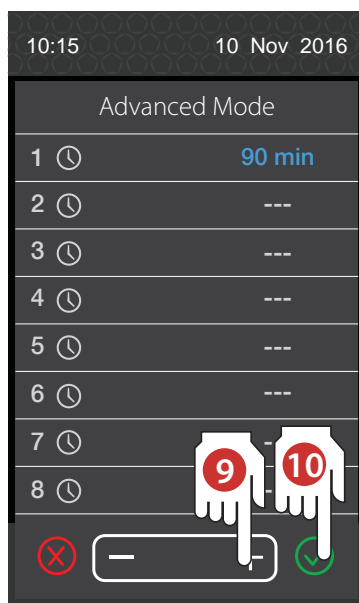



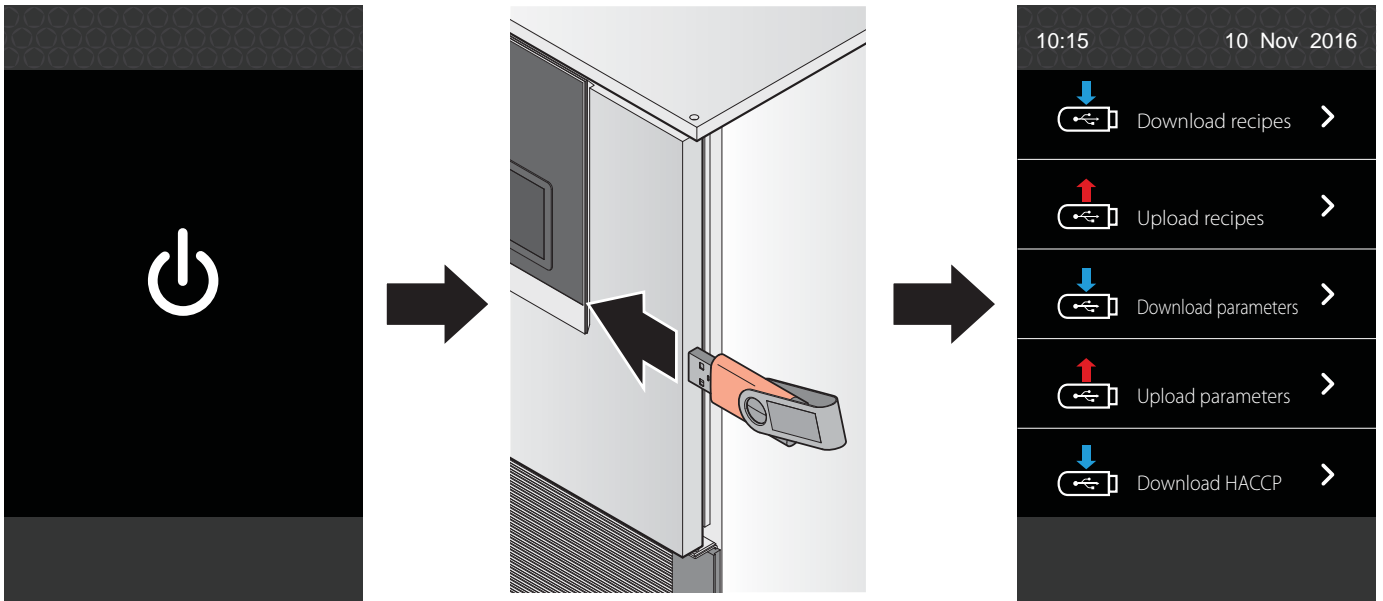

SPECIAL FUNCTIONS

USB MENU

With the display off (OFF), a USB can be inserted (FAT 32 formatted) and the USB screen is automatically displayed.

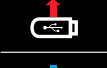

-  **Download recipes:** the entire *My recipes section will be downloaded from the board to the USB key.*
-  **Upload recipes:** the entire *My recipes* section in the USB key will be uploaded to the board.
-  **Download parameters:** all parameters and all set points will be downloaded from the board to the USB key.
-  **Upload parameters:** all parameters and set points in the USB key will be uploaded to the board.
-  **Download HACCP:** log data will be downloaded to the USB key.

Once the operation to be run is selected, the confirmation request appears: press key  to start downloading data and view progress. If the process is successfully completed, press **OK** to return to the USB menu.

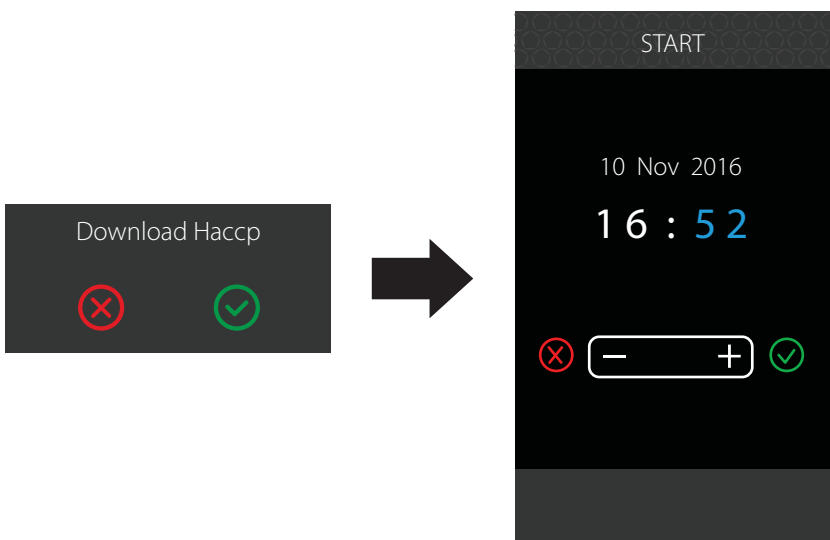
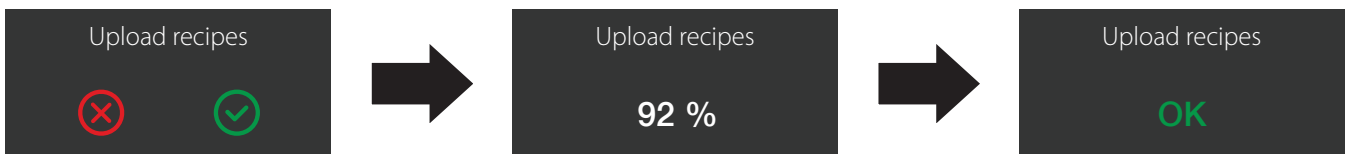

To download HACCP data (**Download HACCP**) confirm the operation with key , to open data download start date and time settings.

SET POINT

In the **Settings** menu select **Service** and then **SetPoint** and enter password 0019 to open the settings menu.

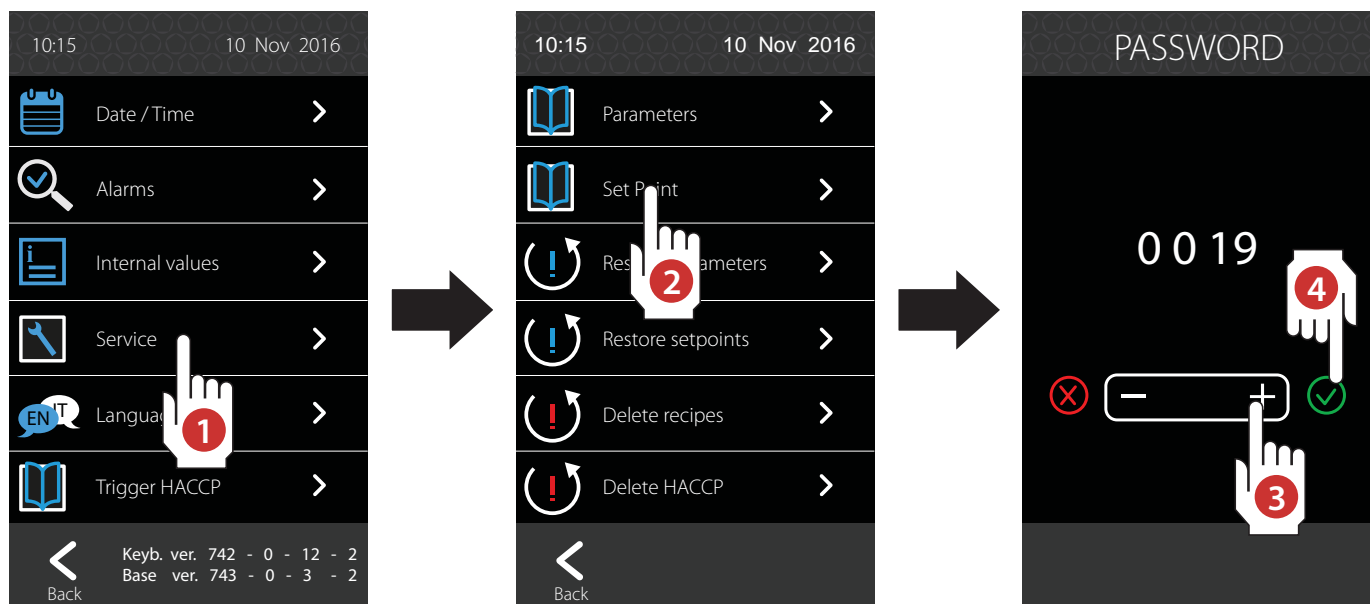

Label	Chilling set point	Default	MIN	MAX
Ab01	PHASE 1 cell set point in chilling +3°C Soft Manual	0°C	-60°C	100°C
Ab02	PHASE 1 core set point in chilling +3°C Soft Manual	10°C	-60°C	100°C
Ab03	PHASE 1 time set point in chilling +3°C Soft Manual full load	30min	0min	240min
Ab04	PHASE 2 cell set point in chilling +3°C Soft Manual	0°C	-60°C	100°C
Ab05	PHASE 2 core set point in chilling +3°C Soft Manual	5°C	-60°C	100°C
Ab06	PHASE 2 time set point in chilling +3°C Soft Manual full load	30min	0min	240min
Ab07	PHASE 3 cell set point in chilling +3°C Soft Manual	0°C	-60°C	100°C
Ab08	PHASE 3 core set point in chilling +3°C Soft Manual	3°C	-60°C	100°C
Ab09	PHASE 3 time set point in chilling +3°C Soft Manual full load	30min	0min	240min
Ab10	Cell set point in storage +3°C Manual	2°C	-60°C	100°C
Ab11	PHASE 1 cell set point in chilling +3°C Hard Manual	-20°C	-60°C	100°C
Ab12	PHASE 1 core set point in chilling +3°C Hard Manual	22°C	-60°C	100°C
Ab13	PHASE 1 time set point in chilling +3°C Hard Manual full load	30min	0min	240min
Ab14	PHASE 2 cell set point in chilling +3°C Hard Manual	-9°C	-60°C	100°C
Ab15	PHASE 2 core set point in chilling +3°C Hard Manual	10°C	-60°C	100°C
Ab16	PHASE 2 time set point in chilling +3°C Hard Manual full load	30min	0min	240min
Ab17	PHASE 3 cell set point in chilling +3°C Hard Manual	0°C	-60°C	100°C
Ab18	PHASE 3 core set point in chilling +3°C Hard Manual	3°C	-60°C	100°C
Ab19	PHASE 3 time set point in chilling +3°C Hard Manual full load	30min	0min	240min
Ab20	Reserved			
Ab21	PHASE 1 cell set point in chilling -18°C Soft Manual	-10°C	-60°C	100°C
Ab22	PHASE 1 core set point in chilling -18°C Soft Manual	3°C	-60°C	100°C
Ab23	PHASE 1 time set point in chilling -18°C Soft Manual full load	80min	0min	240min
Ab24	PHASE 2 cell set point in chilling -18°C Soft Manual	-25°C	-60°C	100°C
Ab25	PHASE 2 core set point in chilling -18°C Soft Manual	-5°C	-60°C	100°C
Ab26	PHASE 2 time set point in chilling -18°C Soft Manual full load	80min	0min	240min
Ab27	PHASE 3 cell set point in chilling -18°C Soft Manual	-40°C	-60°C	100°C
Ab28	PHASE 3 core set point in chilling -18°C Soft Manual	-18°C	-60°C	100°C
Ab29	PHASE 3 time set point in chilling -18°C Soft Manual full load	80min	0min	240min
Ab30	Cell set point in storage -18°C Manual	-20°C	-60°C	100°C

USE - SPECIAL FUNCTIONS

Label	Chilling set point	Default	MIN	MAX
Ab31	PHASE 1 cell set point in chilling -18°C Hard Manual	-40°C	-60°C	100°C
Ab32	PHASE 1 core set point in chilling -18°C Hard Manual	-18°C	-60°C	100°C
Ab33	PHASE 1 time set point in chilling -18°C Hard Manual full load	80min	0min	240min
Ab34	PHASE 2 cell set point in chilling -18°C Hard Manual	-40°C	-60°C	100°C
Ab35	PHASE 2 core set point in chilling -18°C Hard Manual	-18°C	-60°C	100°C
Ab36	PHASE 2 time set point in chilling -18°C Hard Manual full load	80min	0min	240min
Ab37	PHASE 3 cell set point in chilling -18°C Hard Manual	-40°C	-60°C	100°C
Ab38	PHASE 3 core set point in chilling -18°C Hard Manual	-18°C	-60°C	100°C
Ab39	PHASE 3 time set point in chilling -18°C Hard Manual full load	80min	0min	240min
Ab40	Fan speed PHASE 1	5	0	5
Ab41	Fan speed PHASE 2	5	0	5
Ab42	Fan speed PHASE 3	5	0	5
Ab43	Fan speed in storage	5	0	5
Ab44	Maximum chilling time set point +3°C	120min	0min	999min
Ab45	Maximum chilling time set point -18°C	300min	0min	999min
Ab46	PHASE 1 time set point in chilling +3°C Soft Manual half load	30min	0min	240min
Ab47	PHASE 2 time set point in chilling +3°C Soft Manual half load	30min	0min	240min
Ab48	PHASE 3 time set point in chilling +3°C Soft Manual half load	30min	0min	240min
Ab49	PHASE 1 time set point in chilling +3°C Hard Manual half load	30min	0min	240min
Ab50	PHASE 2 time set point in chilling +3°C Hard Manual half load	30min	0min	240min
Ab51	PHASE 3 time set point in chilling +3°C Hard Manual half load	30min	0min	240min
Ab52	PHASE 1 time set point in chilling -18°C Soft Manual half load	80min	0min	240min
Ab53	PHASE 2 time set point in chilling -18°C Soft Manual half load	80min	0min	240min
Ab54	PHASE 3 time set point in chilling -18°C Soft Manual half load	80min	0min	240min
Ab55	PHASE 1 time set point in chilling -18°C Hard Manual half load	80min	0min	240min
Ab56	PHASE 2 time set point in chilling -18°C Hard Manual half load	80min	0min	240min
Ab57	PHASE 3 time set point in chilling -18°C Hard Manual half load	80min	0min	240min
Label	Thawing set point	Default	MIN	MAX
Sc01	Initial set point in thawing cycle with high load	30°C	-60°C	100°C
Sc02	End set point in thawing cycle with high load	12°C	-60°C	100°C
Sc03	Thawing cycle duration with high load	360min	0min	999min
Sc04	Initial set point in thawing cycle with medium load	25°C	-60°C	100°C
Sc05	End set point in thawing cycle with medium load	12°C	-60°C	100°C
Sc06	Thawing cycle duration with medium load	240min	0min	999min
Sc07	Initial set point in thawing cycle with low load	20°C	-60°C	100°C
Sc08	End set point in thawing cycle with low load	12°C	-60°C	100°C
Sc09	Thawing cycle duration with low load	60min	0min	999min
Sc10	Fan speed during phase 1	5	0	5
Sc11	Fan speed during phase 2	5	0	5
Sc12	Fan speed during phase 3	5	0	5
Sc13	Fan speed during phase 4	5	0	5
Sc14	Fan speed during phase 5	5	0	5
Sc15	Dead zone in thawing cycle	1°C	0°C	10°C
Sc16	Heat hysteresis in thawing cycle	2°C	0°C	10°C
Sc17	Cold hysteresis in thawing cycle	2°C	0°C	10°C
Sc18	Storage set point in thawing cycle	3°C	-60°C	100°C
Sc19	Set humidity during phase 1	0	0	5
Sc20	Set humidity during phase 2	0	0	5
Sc21	Set humidity during phase 3	0	0	5
Sc22	Set humidity during phase 4	0	0	5
Sc23	Set humidity during phase 5	0	0	5
Sc24	Set humidity during storage	0	0	5

Label	Cooling set point	Default	MIN	MAX
PR01	Pre-cooling chamber set point	-25°C	-60°C	45°C
PR02	Pre-cooling chamber set point Positive cycles only	-25°C	-60°C	45°C
PR03	Buzzer sounding period at end pre-cooling	60 sec	3 sec	600 sec
Label	Anisakis Killer set point	Default	MIN	MAX
AK01	Chamber set point in chilling	-40°C	-60°C	100°C
AK02	Needle Probe set point end chilling	-20°C	-60°C	100°C
AK03	Maintenance phase duration	24 h	1 h	99 h
AK04	Chamber set point in storage	-20°C	-60°C	100°C
AK05	Maximum phase 1 needle probe duration	5 h	1 h	99 h
Label	Retarder set point	Default	MIN	MAX
FL01	FL04, FL05, FL06 parameter offset	2°C	1°C	15°C
FL02	Minimum settable set point for the block, storage and manual refrigeration phases.	-22°C	-99°C	FL03
FL03	Maximum settable set point for the block, storage and manual refrigeration phases.	25°C	FL02	45°C
FL04	neutral cold zone for block, storage and manual refrigeration phases	1°C	0°C	10°C
FL05	neutral cold zone for activation, rising and manual heating phases	3°C	0°C	10°C
FL06	neutral cold zone for delay baking phase	1°C	0°C	10°C
FL07	FL10, FL11 parameter offset	1°C	1°C	15°C
FL08	Minimum settable set point for the activation, rising, delay baking and manual heating phases.	0°C	-99°C	FL09
FL09	Maximum settable set point for the activation, rising, delay baking and manual heating phases.	40°C	FL08	45°C
FL10	neutral hot zone for activation, rising and manual heating phases	0°C	0°C	10°C
FL11	neutral hot zone for delay baking phase	1°C	0°C	10°C
FL12	Cycle time to turn on the heating resistances in the event of heat request	60 sec	1 sec	600sec
FL13	Heating resistance activation time in cycle time FL12	45 sec	1 sec	600 sec
FL14	Number of resistance regulation steps in activation phase	4	1	10
FL15	Percent 1st activation step increase	25%	0%	FL16
FL16	Percent 2nd activation step increase	50%	FL15	FL17
FL17	Percent 3rd activation step increase	75%	FL16	FL18
FL18	Percent 4th activation step increase	100%	FL17	100
FL19	Percent 5th activation step increase	----	FL18	FL20
FL20	Percent 6th activation step increase	----	FL19	FL21
FL21	Percent 7th activation step increase	----	FL20	FL22
FL22	Percent 8th activation step increase	----	FL21	FL23
FL23	Percent 9th activation step increase	----	FL22	FL24
FL24	Percent 10th activation step increase	----	FL23	100%
<p>NOTE: visibility of parameters FL15 to FL24 depends on the number of regulation steps selected with parameters FL14. Consequently, even the parameter default value will change to have a linear percent increase as default. Example of 4 regulation steps: FL15 25%, FL16 50%, FL17 75%, FL18 100%</p> <p>Example of 7 regulation steps: FL15 14%, FL16 29%, FL17 43%, FL18 57%, FL19 71%, FL20 86%, FL21 100%</p>				
FL25	Number of resistance regulation steps in rising phase	4	1	10
FL26	Percent 1st rising step increase	25%	0%	FL27
FL27	Percent 2nd rising step increase	50%	FL26	FL28
FL28	Percent 3rd rising step increase	75%	FL27	FL29
FL29	Percent 4th rising step increase	100%	FL28	100
FL30	Percent 5th rising step increase	----	FL29	FL31
FL31	Percent 6th rising step increase	----	FL30	FL32

USE - SPECIAL FUNCTIONS

Label	Retarder set point	Default	MIN	MAX
FL32	Percent 7th rising step increase	----	FL31	FL33
FL33	Percent 8th rising step increase	----	FL32	FL34
FL34	Percent 9th rising step increase	----	FL33	FL35
FL35	Percent 10th rising step increase	----	FL34	100%
NOTE: visibility of parameters FL15 to FL24 depends on the number of regulation steps selected with parameters FL14. Consequently, even the parameter default value will change to have a linear percent increase as default. Example of 4 regulation steps: FL15 25%, FL16 50%, FL17 75%, FL18 100% Example of 7 regulation steps: FL15 14%, FL16 29%, FL17 43%, FL18 57%, FL19 71%, FL20 86%, FL21 100%				
FL36	Humidity control mode: 0 = with humidity probe 1 = timed cycles based on set percent	1	0	1
FL37	Minimum cell temperature under which humidifying/dehumidifying control is inhibited	10°C	-99°C	45°C
FL38	Cycle time for humidifier start (if FL36 = 1)	60sec	1sec	600sec
FL39	Humidifier start time win FL38 cycle time to generate 100% humidity in the cell (if FL36 =1)	30sec	1sec	600sec
FL40	Humidification/dehumidification control on during block and storage phases	0	0	1
FL41	dehumidification offset	5 %rH	1 %rH	100 %rH
FL42	neutral dehumidification zone value	2 %rH	0 %rH	100 %rH
FL43	dehumidification attempt duration with pump-down solenoid valve	10 sec	0 sec	255 sec
FL44	humidification offset	5 %rH	1 %rH	100 %rH
FL45	neutral humidification zone value	2 %rH	0 %rH	100 %rH
FL46	humidification proportional band value	10 %rH	0 %rH	50 %rH
FL47	Cycle time for proportional humidification regulation	30sec	0sec	255sec
FL48	Base times for proportional humidification regulation cycle time: 0 = seconds; 1 = minutes	0	0	1
FL49	Forced compressor activation at Activation and R	0min	0min	240min
FL50	Reserved			
FL51	Reserved			
FL55	Reserved			
FL53	Reserved			
Label	Slow cooking set point	Default	MIN	MAX
CL01	Meat cooking chamber temperature set phase 1	85°C	20°C	85°C
CL02	Meat cooking time set phase 1	1min	-1 (INF)	900 min
CL03	Meat needle probe cooking set phase 1	20°C	0°C	85°C
CL04	Meat cooking fan set phase 1	5	0	5
CL05	Meat cooking humidity set phase 1	0	0	5
CL06	Fish cooking chamber temperature set phase 1	85°C	20°C	85°C
CL07	Fish cooking time set phase 1	1min	-1 (INF)	900 min
CL08	Fish needle probe cooking set phase 1	20°C	0°C	85°C
CL09	Fish cooking fan set phase 1	5	0	5
CL10	Fish cooking humidity set phase 1	0	0	5
CL11	Pastry cooking chamber temperature set phase 1	85°C	20°C	85°C
CL12	Pastry cooking time set phase 1	1min	-1 (INF)	900 min
CL13	Pastry needle probe cooking set phase 1	20°C	0°C	85°C
CL14	Pastry cooking fan set phase 1	5	0	5
CL15	Pastry cooking humidity set phase 1	0	0	5
CL16	Meat cooking chamber temperature set phase 2	85°C	20°C	85°C
CL17	Meat cooking time set phase 2	1min	-1 (INF)	900 min
CL18	Meat needle probe cooking set phase 2	20°C	0°C	85°C

Label	Slow cooking set point	Default	MIN	MAX
CL19	Meat cooking fan set phase 2	5	0	5
CL20	Meat cooking humidity set phase 2	0	0	5
CL21	Fish cooking chamber temperature set phase 2	85°C	20°C	85°C
CL22	Fish cooking time set phase 2	1min	-1 (INF)	900 min
CL23	Fish needle probe cooking set phase 2	20°C	0°C	85°C
CL24	Fish cooking fan set phase 2	5	0	5
CL25	Fish cooking humidity set phase 2	0	0	5
CL26	Pastry cooking chamber temperature set phase 2	85°C	20°C	85°C
CL27	Pastry cooking time set phase 2	1min	-1 (INF)	900 min
CL28	Pastry needle probe cooking set phase 2	20°C	0°C	85°C
CL29	Pastry cooking fan set phase 2	5	0	5
CL30	Pastry cooking humidity set phase 2	0	0	5
CL31	Chamber set in storage	65°C	20°C	85°C
CL32	Fan set in storage	1	0	5
CL33	Humidity set in storage	0	0	5
CL34	Resistance activation period in proportional band (Conf120)	60 sec	0 sec	600 sec
Label	Drying set point	Default	MIN	MAX
As01	Number of drying cycles	4	1	10
As02	Heating set point	45°C	0°C	85°C
As03	Cooling set point	15°C	0°C	85°C
As04	Pause time	120 sec	0 sec	999 sec
As05	Drying fan set	5	0	5
As06	Evaporator set point: the compressor turns off under it	0°C	-60°C	85°C

PARAMETERS

In the **Settings** menu select **Service** and then **SetPoint** and enter password 00-19 to open the settings menu.

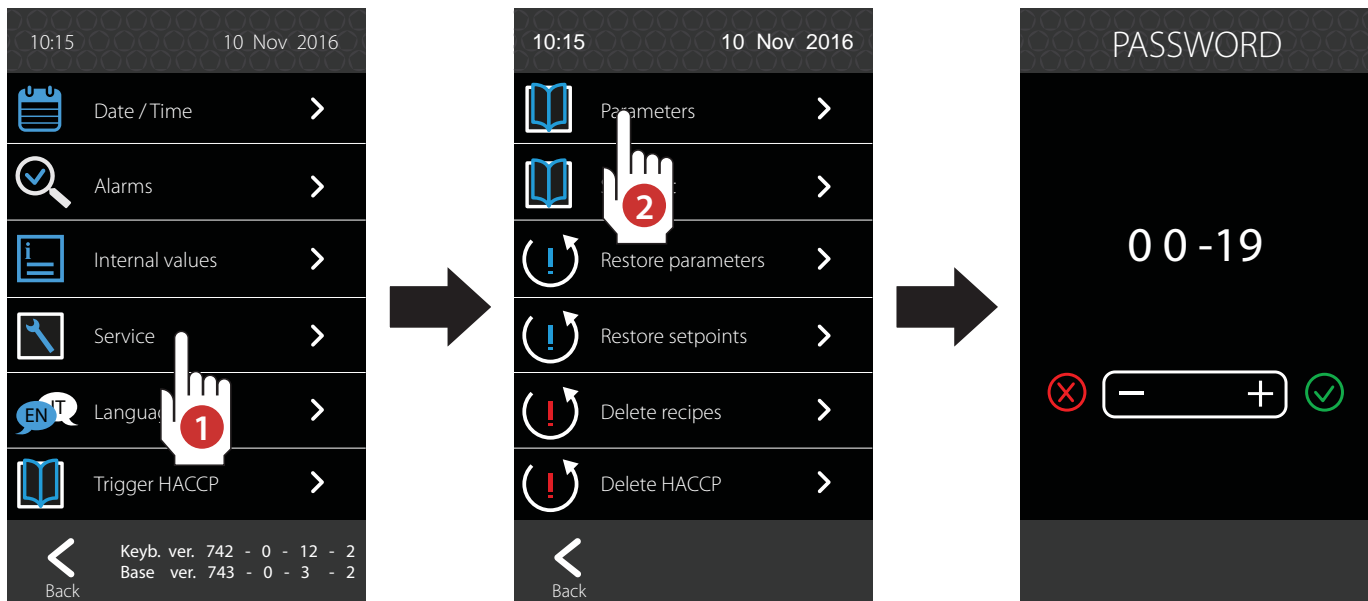

Label	Machine configuration	Default	min	MAX
Conf00	Hysteresis for temperature alarm reset	2°C	0°C	10°C
Conf01	High Temperature alarm threshold in positive storage for Set CONS	7°C	0°C	50°C
Conf02	Low Temperature alarm threshold in positive storage	0°C	-10°C	0°C
Conf03	High Temperature alarm threshold in negative storage for Set CONS	6°C	0°C	50°C
Conf04	Low Temperature alarm threshold in negative storage for Set CONS	-10°C	-50°C	0°C
Conf05	Temperature alarm delay from start storage or defrost	60min	0min	300min
Conf06	Temperature alarm delay	30min	0min	300min
Conf07	Maximum blackout duration	2min	0min	300min
Conf08	Keyboard lock timeout	180sec	0sec	600sec
Conf09	0: Celsius; 1: Fahrenheit	0	0	1
Conf10	Cell probe offset	0°C	-10°C	10°C
Conf11	Evaporator probe offset	0°C	-10°C	10°C
Conf12	Condenser Probe offset	0°C	-10°C	10°C
Conf13	Needle Probe 1 offset	0°C	-10°C	10°C
Conf14	Needle Probe 2 offset	0°C	-10°C	10°C
Conf15	Needle Probe 3 offset	0°C	-10°C	10°C
Conf16	Needle Probe 4 offset	0°C	-10°C	10°C
Conf17	Door open polarity 0: DI closed = door Closed 1: DI closed = door Open	0	0	1
Conf18	Door Open alarm delay	2 min	0 min	60 min
Conf19	Enable buzzer (0 disabled; 1 Enabled)	1	0	1
Conf20	Buzzer duration at end chilling cycle	10 sec	0 sec	600 sec
Conf21	Alarm buzzer duration	1 min	0 min	90 min
Conf22	Enable needle probe acknowledge (0 disabled; 1 Enabled)	0	0	1
Conf23	Positive Chilling cycles only: 0 = Positive and Negative cycles 1 = Positive cycles only	0	0	1

Label	Machine configuration	Default	min	MAX
Conf24	HP alarm detection time	5 sec	0 sec	60 sec
Conf25	High Pressure digital input polarity 0: DI Open = HP alarm on 1: DI Closed = HP alarm on	0	0	1
Conf26	effect caused by high pressure input activation: 0=no effect 1= Alarm, the compressor and evaporator fan turn off and the condenser fan turns on	1	0	1
Conf27	LP alarm detection time	5 sec	0 sec	60 sec
Conf28	Low Pressure digital input polarity 0: DI Open = LP alarm on 1: DI closed = LP alarm on	0	0	1
Conf29	effect caused by low pressure input activation: 0=no effect 1 = Low Pressure alarm: the compressor, heating and evaporator fan are turned off. 2= Pumpdown and alarm management: in cooling system shutdown, the input will turn of the compressor output; if the input does not trigger at the end of pumpdown time, the compressor turns off and an alarm is generated. 3 = Compressor overload alarm: the compressor and fans and resistances will be turned off.	3	0	3
Conf30	Thermostat alarm detection time	5 sec	0 sec	60 sec
Conf31	Thermostat digital input polarity 0: DI Open = Thermostat alarm on 1: DI closed = Thermostat alarm on	0	0	1
Conf32	effect caused by thermostat input activation: 0=no effect 1 = Alarm; the compressor and fans and resistances will be turned off.	1	0	1
Conf33	Door resistance on set point	10°C	-10°C	20°C
Conf34	UVC sterilisation duration	15 min	0 min	999 min
Conf35	Minimum temperature for start sterilisation	15°C	0°C	100°C
Conf36	Temperature under which needle probe heating can start	-5°C	-50°C	50°C
Conf37	Needle Probe Heating duration	90 sec	0 sec	600 sec
Conf38	End needle probe heating temperature	30°C	0°C	100°C
Conf39	Compressor on off hysteresis	1°C	0°C	20°C
Conf40	Minimum compressor shutdown time	2 min	0 min	30 min
Conf41	Minimum compressor on time	0 sec	0 sec	300 sec
Conf42	Minimum time between two compressor starts	0 min	0 min	30 min
Conf43	Reserved			
Conf44	Delta set point in needle probe control with cell probe error	-2°C	-10°C	10°C
Conf45	Minimum needle probe temperature for start chilling	70°C	0°C	90°C
Conf46	Needle probe insertion test duration	3 min	1 min	240 min
Conf47	Fan ON with compressor off in storage	30 sec	0 sec	999 sec
Conf48	Fan OFF with compressor off in storage	120 sec	0 sec	999 sec
Conf49	Temperature difference at core in needle probe insertion test	4°C	0	10°C
Conf50	Temperature difference between cell and core in needle probe insertion test	5°C	0	10°C
Conf51	Instrument address	1	1	247
Conf52	Serial management: 0=not used; 1= ModBus	1	0	1
Conf53	BaudRate: 0 = 2400; 1 = 4800; 2 = 9600; 3 = 19200	2	0	3

USE - SPECIAL FUNCTIONS

Label	Machine configuration	Default	min	MAX
Conf54	Parity : 0 = no parity; 1 = odd; 2 = even	2	0	2
Conf55	Sampling time	10 min	1 min	60 min
Conf56	Run defrost at start chilling 0 = No; 1 = Yes	0	0	1
Conf57	End defrost temperature	15°C	-10°C	30°C
Conf58	Maximum defrost duration	15 min	1 min	90 min
Conf59	Interval between two defrosts in storage (0=excluded)	8 hours	0 hours	18 hours
Conf60	Defrost type: 0= air; 1= hot gas; 2= electric	1	0	2
Conf61	Dripping time	1 min	0 min	90 min
Conf62	Compressor start delay with hot gas defrost	0 sec	0 sec	600 sec
Conf63	Temperature under which defrost can start	3°C	-10°C	30°C
Conf64	Fan stop temperature delta after defrost	5°C	0°C	10°C
Conf65	Compressor ON time in Pos cycles with Chamber probe fault	3 min	0 min	60 min
Conf66	Compressor OFF time in Pos cycles with Chamber probe fault	7 min	0 min	60 min
Conf67	Compressor ON time in Neg cycles with Chamber probe fault	8 min	0 min	60 min
Conf68	Compressor OFF time in Neg cycles with Chamber probe fault	2 min	0 min	60 min
Conf69	Compressor on delay from Power-On	2 min	0 min	30 min
Conf70	Minimum speed settable by the user	1	0	5
Conf71	Maximum speed settable by the user	5	0	5
Conf72	PWM fan peak speed	80%	0%	100%
Conf73	PWM fan peak time	5 sec	0 sec	600 sec
Conf74	Initial splash	1	0	10
Conf75	Machine type: 0=Gastronomy; 1=Pastry	0	0	1
Conf76	Minimum PWM fan linearised speed	10%	0%	100%
Conf77	Maximum PWM fan linearised speed	60%	0%	100%
Conf78	Enable Evaporator fan regulation temperature set	25°C	-50°C	50°C
Conf79	Reserved			
Conf80	condenser temperature over which the over which overheated condenser alarm triggers	80°C	0°C	200°C
Conf81	condenser temperature over which the over which compressor blocked alarm triggers	90°C	0°C	200°C
Conf82	compressor blocked alarm delay	1 min	0 min	15 min
Conf83	Compressor shutdown delay (Pumpdown)	10 sec	0 sec	600 sec
Conf84	Solenoid start delay (Pumpdown)	5 sec	0 sec	600 sec
Conf85	Reserved			
Conf86	fan operations in thawing: 0=parallel to compressor/resistances; 1=always ON	1	0	1
Conf87	Enable evaporator probe: 0 = No; 1 = Yes	1	0	1
Conf88	Enable condenser probe: 0 = No; 1 = Yes	0	0	1
Conf89	Blackout duration during a cycle over which the cycle is interrupted	15min	0min	60min
Conf90	Instrument behaviour at restored power 0 = the cycle is interrupted 1 = the cycle is resumed 2 = the cycle is resumed if the interruption duration was under parameter Conf89	1	0	2
Conf91	Reserved			
Conf92	evaporator fan speed during dehumidification	2	0	5
Conf93	evaporator fan shutdown delay from compressor/heating resistance shutdown (only valid for operations in parallel)	0sec	0sec	240sec
Conf94	Cycle time for evaporator fan start (valid when fans should be off)	60sec	0sec	600sec

Label	Machine configuration	Default	min	MAX
Conf95	Evaporator fan activation time in cycle time Conf94	60sec	0sec	600sec
Conf96	Evaporator Fan: 0=Inverter; 1=PWM	1	0	1
Conf97	evaporator fan delay at door closure	3sec	0sec	240sec
Conf98	Inverter fans speed 1	500 rpm	400 rpm	600 rpm
Conf99	Inverter fans speed 2	700 rpm	600 rpm	800 rpm
Conf100	Inverter fans speed 3	900 rpm	800 rpm	1000 rpm
Conf101	Inverter fans speed 4	1100 rpm	1000 rpm	1200 rpm
Conf102	Inverter fans speed 5	1300 rpm	1200 rpm	1400 rpm
Conf103	PWM fans speed 1	20%	0%	100%
Conf104	PWM fans speed 2	40%	0%	100%
Conf105	PWM fans speed 3	60%	0%	100%
Conf106	PWM fans speed 4	80%	0%	100%
Conf107	PWM fans speed 5	100%	0%	100%
Conf108	Sterilisation: 0=Sterilox; 1=UVC	0	0	1
Conf109	Condenser fan activation hysteresis	2°C	0°C	20°C
Conf110	Condenser fan activation set point	15°C	-50°C	50°C
Conf111	Condenser fans during defrosting 0 = fans OFF; 1 = fans ON	0	0	1
Conf112	Condenser fan shutdown delay from compressor shutdown (only valid with condenser probe disabled)	30 sec	0 sec	300 sec
Conf113	Sterilisation duration with Sterilox	30 min	0 min	999 min
Conf114	Fan operations in Block phase: 0=parallel to compressor; 1=always ON	1	0	1
Conf115	Fan operations in Storage phase: 0=parallel to compressor; 1=always ON	1	0	1
Conf116	Fan operations in Activation phase: 0=parallel to compressor; 1=always ON	1	0	1
Conf117	Fan operations in Rising phase: 0=parallel to compressor; 1=always ON	1	0	1
Conf118	Fan operations in Delay baking phase: 0=parallel to compressor; 1=always ON	1	0	1
Conf119	Door effect: 0=no effect; 1= Evaporator, Compressor and heating resistance fan off; 2= Evaporator and heating resistance fan off;	2	0	2
Conf120	Heating proportional band in cooking	5°C	0°C	20°C
Conf121	Spray time in humidification during cooking	2sec	0sec	60sec
Conf122	Cycle time in humidification during cooking	15min	0min	999min
Conf123	Humidification activation delay at start cooking	1min	0min	99min
Conf124	Spray time in humidification during thawing	2sec	0sec	60sec
Conf125	Cycle time in humidification during thawing	15min	0min	999min
Conf126	Humidification activation delay at start thawing	90min	0min	99min
Conf127	Spray time in humidification during leavening retarder	2sec	0sec	60sec
Conf128	Cycle time in humidification during leavening retarder	15min	0min	999min
Conf129	Humidification activation delay at start leavening retarder	0min	0min	99min
Conf130	Continuous Cycle set point	0°C	-50°C	85°C
Conf131	Fan set in continuous cycle	5	0	5

MAINTENANCE



BEFORE PERFORMING ANY MAINTENANCE, CUT OFF THE POWER SUPPLY TO THE MACHINE AND WEAR SUITABLE PERSONAL PROTECTION EQUIPMENT (E.G. GLOVES, ETC.).



THE USER MUST ONLY PERFORM ROUTINE MAINTENANCE OPERATIONS (MEANING CLEANING). FOR EXTRAORDINARY MAINTENANCE, CONTACT A SERVICE CENTRE REQUESTING SERVICE FROM AN AUTHORISED TECHNICIAN.



THE WARRANTY IS NULL AND VOID IN THE EVENT OF DAMAGES DUE TO NEGLIGENT OR INCORRECT MAINTENANCE (E.G. USE OF UNSUITABLE DETERGENTS).

To clean any component or accessory, DO NOT use:

- abrasive or powder detergents;
- aggressive or corrosive detergents (e.g. hydrochloric or sulphuric acid, caustic soda, etc.). Warning! Do not even use these substances to clean the floor under the equipment;
- abrasive or sharp tools (e.g. abrasive sponges, scrapers, steel brushes, etc.);
- steamed or pressurised water jets.

At first use wash the trays and chamber using a cloth dampened with hot soapy water and end with rinsing and drying. To eliminate work residue, run the equipment empty for about 30 minutes selecting the **Slow Cooking** function.

External steel surface cleaning

If the **Slow Cooking** function was used, wait until the equipment cools and then use a cloth dampened with hot soapy water or specific products for steel. End with rinsing and drying.

Equipment chamber cleaning

Daily clean the equipment chamber to maintain high levels of hygiene and equipment performance. Grease particles or food residue could catch fire when using the **Slow Cooking** function, causing personal and equipment damages.

Always clean when the chamber is cool: use a cloth dampened with hot soapy water and end with rinsing and drying.

The equipment can be cleaned and rinsed with the specific shower head sold separately, connecting it to the fitting that protrudes from the front panel under the door (see illustration).

Cleaning water, once the plug is removed inside the chamber, drains into the collection tank on the bottom of the equipment or directly into the drain siphon if installed. To remove the shower head, press the metallic connector button on the panel; both fittings are equipped with water check valves at release. Do not leave the shower kit in the equipment when running to avoid damages.

When finished, the interior can be dried by running drying cycles.



For further information on how to run the drying function, see page 52.

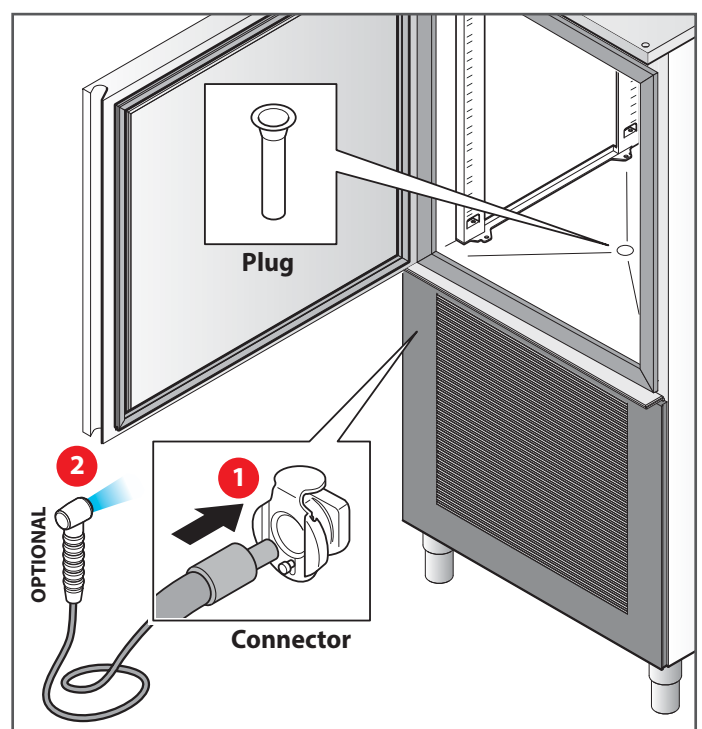
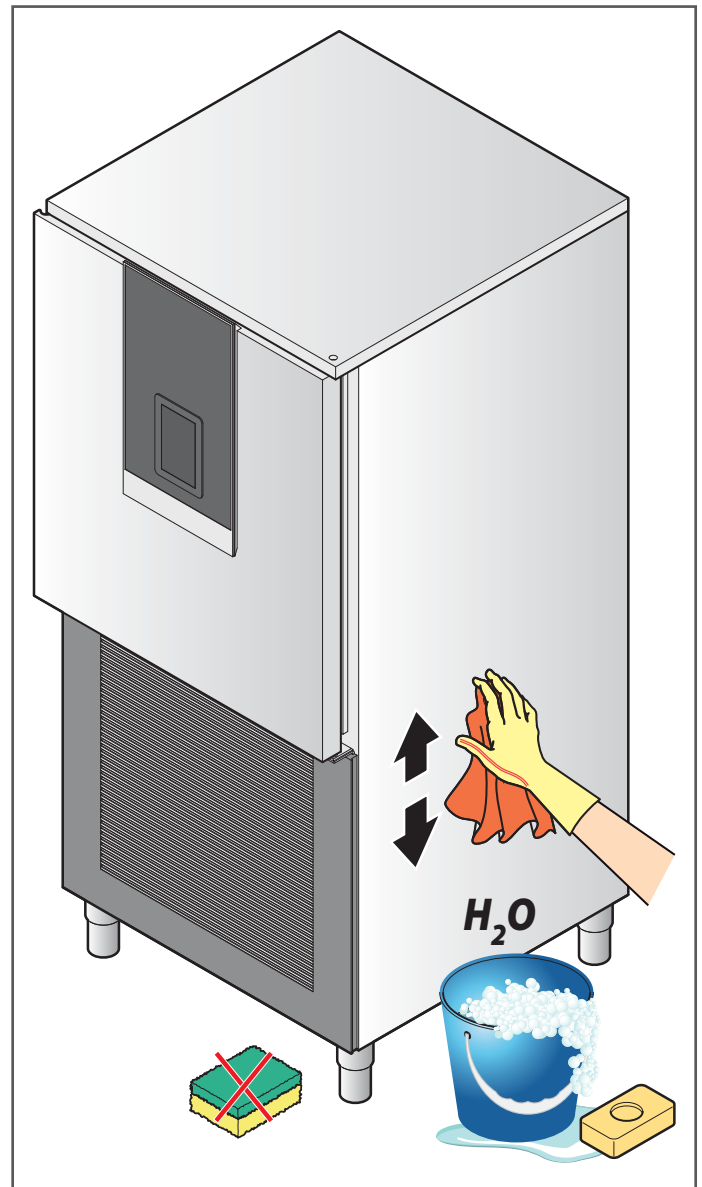

Touch screen

If the **Slow Cooking** function was used, wait until the equipment cools. Next, use a cloth slightly dampened with a product specific for glass following the detergent manufacturer's instructions. Do not spray too much product to avoid infiltrations that could damage the display.

Vent cleaning

Keep vents free of obstructions and dust cleaning them often with a normal vacuum or brush.

We recommend you remove the front panel once a week following the illustrated instructions and cleaning the filter with hot soapy water. If replacement is required, contact the manufacturer to order spare parts.

Disuse

Cut-off the power and water mains in the event of disuse. Protect external steel equipment parts wiping them down with a soft cloth slightly dampened with Vaseline oil.

Leave the door ajar to guarantee correct ventilation.

Before resuming operations:

- accurately clean the equipment and accessories;
- reconnect the equipment to the power and water mains;
- inspect the equipment before using it;
- restart the equipment at a low temperature for at least 60 minutes without any food inside.

 **To ensure that the device is in perfect use and safety conditions, we recommend you have it maintained and serviced by an authorised service centre at least once a year.**

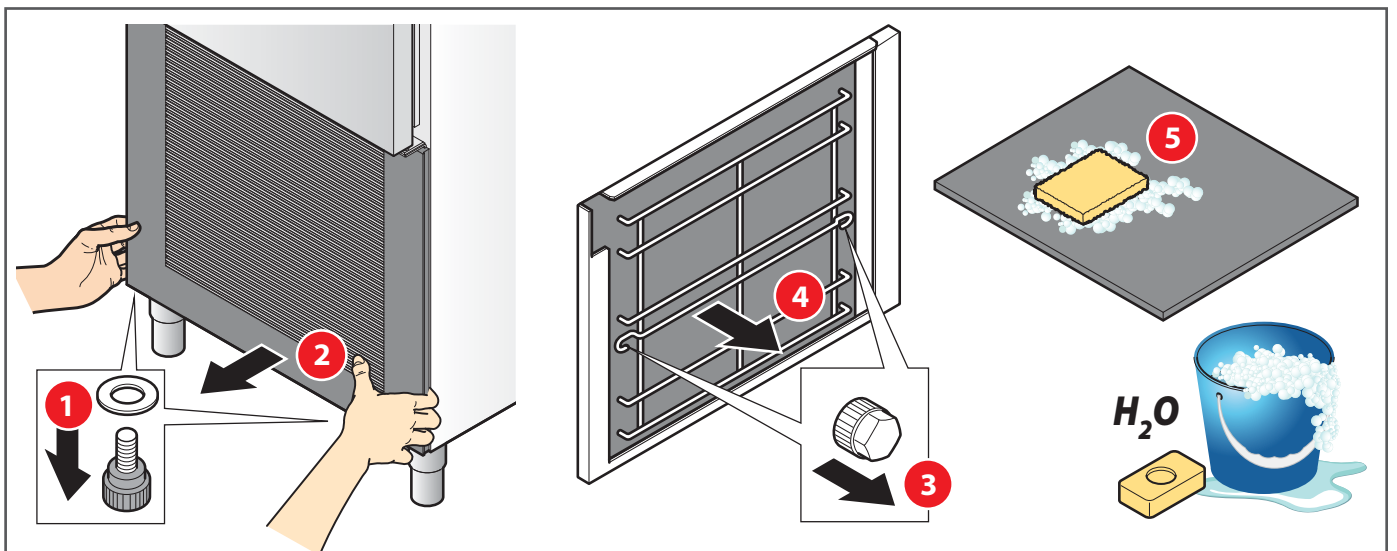
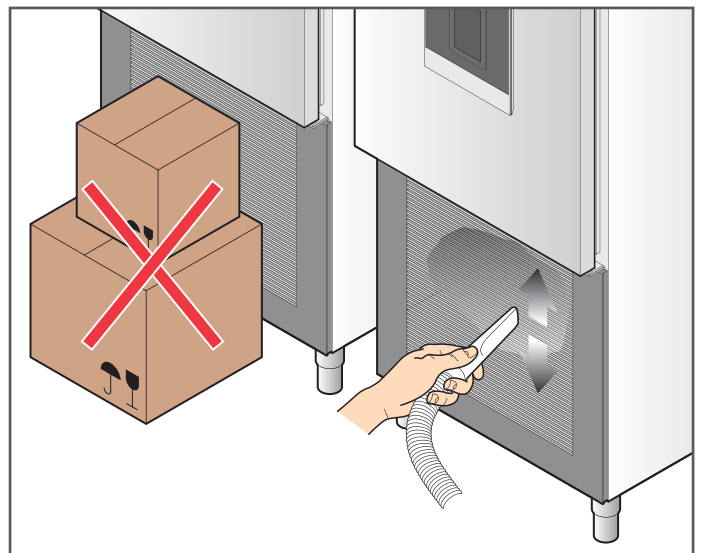

MAINTENANCE

CUSTOMER SERVICE

If the equipment does not work or functional or structural alterations are noted:

- disconnect it from the power and water mains;
- consult the table below to check the proposed solutions;

If the solution is not found in the table, contact a manufacturer's authorised service centre communicating:

- the nature of the defect;
- the equipment code and serial number found on its specification plate.

Require original spare parts for repairs: the manufacturer cannot be held liable and null and voids the warranty in the event non original spare parts are used.

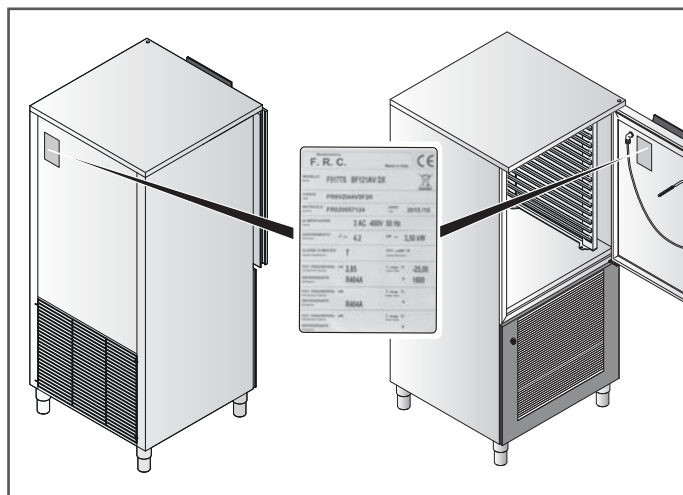

To ensure that the device is in perfect use and safety conditions, we recommend you have it maintained and serviced by an authorised service centre at least once a year.

Manufacturer data:

ALI Spa F.R.C.
Via Treviso, 4
33083 Chions, Pordenone Italy
Tel +39 0434.635411

Problem type	Before contacting a service centre, check that...
The device is fully off.	- ...the system is powered and the plug is not disconnected.
The equipment does not cool enough	- ...it is not effected by an external heat source; - ...the doors are fully shut; - ...the condenser filter is not clogged; - ...the front air vents are not obstructed by objects or dust; - ...food is well distributed in the cell and do not obstruct ventilation in the cell; - ...the equipment is not overloaded with food (follow your equipment load instructions).
The equipment is very noisy	- ... there are no contacts between the equipment and any other object or machine; - ...the equipment is perfectly levelled; - ...visible screws are well-tightened.



Do not attempt to repair the equipment on your own. This could cause serious damages to humans, animals and property and null and voids the Warranty.
Always request service by a service centre authorised by the manufacturer and request ORIGINAL spare parts.

When an alarm triggers, it is signalled at the top of the display which turns red.

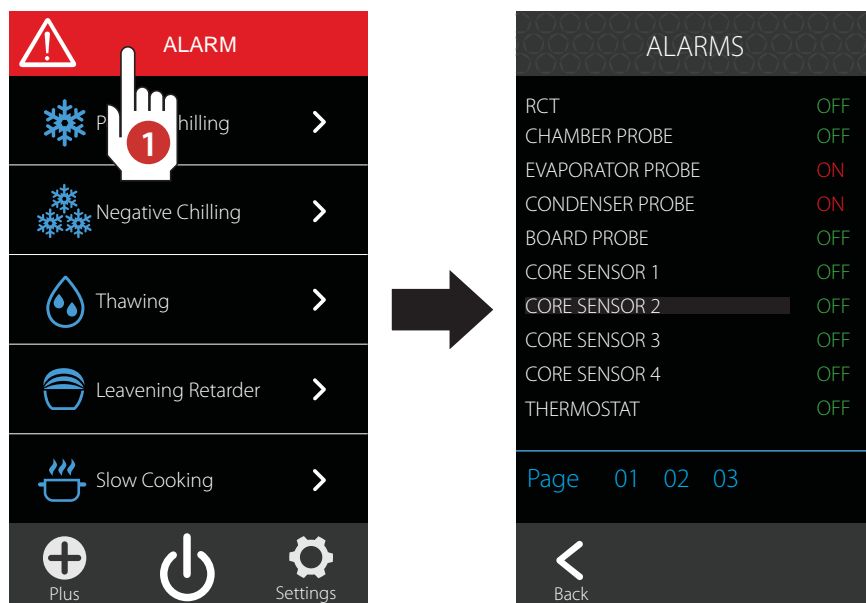

Touch the alarm message to view a detailed description of the alarm type.

Chamber Probe Alarm (Contact customer service)

A probe fault triggers the Chamber Probe Alarm and the buzzer and alarm relay trigger. The alarm is signalled at the top of the display. The buzzer sounds. It can be muted by touching the display. When the fault is fixed, the alarm automatically resets and the alarm relay turns off.

With the Chamber Probe broken, the following program can be started or continued:

- **Timed Chilling** (compressor control is on the Needle Probe).
- **Temperature Chilling** not yet started switches to Timed at Start.
- **Temperature Chilling** in progress, switches to Timed if the Needle Probe is not inserted; the compressor is controlled on the Needle Probe instead of on the Cell probe.
- **Temperature Chilling** in progress with Needle Probe inserted, the compressor turns on and off according to the set times.

Evaporator Probe Alarm (Contact customer service)

A probe fault triggers an Evaporator Probe Alarm. The alarm is signalled at the top of the display, the buzzer sounds and can be muted by touching the display.

At the end of the fault the alarm is automatically reset.

High Temperature alarm during storage

If the temperature remains over the set point during positive or negative storage for a time set by the parameter, a High Temperature alarm triggers. The alarm is signalled at the top of the display.

The buzzer sounds and can be muted by touching the display. When the temperature returns under the alarm threshold, it is automatically reset. The alarm is saved in the HACCP log.

Low Temperature alarm during storage

If the temperature remains under the set point during positive or negative storage for a time set by the parameter, a Low Temperature alarm triggers. The alarm is signalled at the top of the display.

The buzzer sounds and can be muted by touching the display. When the temperature returns over the alarm threshold, it is automatically reset. The alarm is saved in the HACCP log.

Needle Probe Alarm (Contact customer service)

A Needle Probe alarm triggers a Needle Probe fault alarm when in Stand-by or if a Temperature chilling cycle is in progress (in this case, the cycle automatically switches to timed) or during needle probe cooking (in this case cooking ends). The alarm is signalled at the top of the display, the buzzer can be muted by touching the display.

At the end of the fault the alarm is automatically reset. For Multi-top needle probe, a single sensor fault triggers the alarm.

Door Open alarm

The door open alarm triggers after a delay set by the parameter. The compressor immediately stops and that alarm is signalled at the top of the display- The buzzer sounds and can be muted by touching the display. The alarm is automatically reset when the door is closed.

HP pressure gauge Alarm (Contact customer service)

ALARMS

When the HP pressure gauge alarm is detected by the board, the chilling cycles in progress immediately end. The compressor and evaporator fans immediately stop and the alarm is signalled at the top of the display.

The buzzer sounds and can be muted by touching the display.

At the end of the fault the alarm is automatically reset.

LP pressure gauge alarm (only for models where applicable) (Contact customer service)

When the LP pressure gauge alarm is detected by the board, the chilling cycles in progress immediately end. The compressor and evaporator fans immediately stop and the alarm is signalled at the top of the display.

The buzzer sounds and can be muted by touching the display.

At the end of the fault the alarm is automatically reset.

Compressor overload alarm (only for models where applicable) (Contact customer service)

When the compressor overload alarm is detected by the board, the chilling cycles in progress immediately end.

The compressor and evaporator fans stop and the alarm is signalled at the top of the display.

The buzzer sounds and can be muted by touching the display.

At the end of the fault the alarm is automatically reset.

Safety Thermostat alarm (Contact customer service)

When the thermostat alarm is detected by the board, the chilling cycles in progress immediately end.

The compressor, fans and heating resistances immediately turn off.

The alarm is signalled at the top of the display.

The buzzer sounds and can be muted by touching the display.

At the end of the fault the alarm is automatically reset.

Blackout alarm

When a blackout alarm occurs during a cycle in progress, the machine resumes the cycle from where it left off when power returns.

Chilling time tolerance is 10 minutes.

The buzzer can be muted by touching the display.



Only qualified personnel can disconnect the machine from the electrical and water mains.

If applicable, recovery and correctly dispose:

- coolant gas;
- anti-freeze solutions in the hydraulic circuits, avoiding spills or disposal in the environment.

As per Legislative Decree no. 49 art. 13 dated 2014 "Implementation of WEEE Directive 2012/19/EU on electric and electronic waste"



The barred bin markings specify that the product was issued on the market after August 13, 2015 and should not be assimilated with other waste that at the end of its working life but disposed of separately.

All equipment is made of recyclable metallic materials (stainless steel, iron, aluminium, galvanised sheet metal, copper, etc-) in percentages over 90% in weight.

Put the equipment out of order for disposal removing the power cord and any compartment or chamber lock devices (where applicable).

Pay attention to managing this product at the end of its working life, reducing negative impacts on the environment and improving resource use efficiency, applying the "who pollutes pays", prevention, reuse, recycling and recovery preparation principles.

Please remember that illicit or incorrect product disposal is punishable by law.

Information on disposal in Italy

WEEE equipment in Italy must be delivered to:

- Collection centres (also called ecological islands or platforms)
- the dealer where new equipment is purchased who must withdraw it free of charge ("one to one" withdrawal);

Information on disposal in European Union countries

The Community Directive on WEEE equipment was assimilated in different ways in each country. Therefore we suggest you contact your local authorities or Dealer to request the correct disposal method.



Awaiting dismantling and disposal, the equipment can be temporarily stored even outdoors, provided the electrical, refrigeration and hydraulic circuits are integral and closed. Also make sure the doors cannot be closed to avoid entrapment. Follow the environmental protection laws in the user's country.

WARRANTY

The manufacturer's warranty on the equipment and its parts regarding its production is for 1 year, from invoice date, and consists in the free supply of parts to be replaced which, at its sole discretion, are defective.

The manufacturer shall thus remove any faults and defects provided the equipment was installed and used correctly according to the instructions in this manual. The warranty does not cover damages due to lime deposits, power surges or tampering by unauthorised or unskilled personnel.

Consumables such as glass, aesthetic parts, gaskets, lamps and other parts consumed during use are not covered by the warranty.

Labour, travel or missions, part transport and any other expenses for equipment to be replaced are at the purchaser's expense during the warranty period.

Material replaced under the warranty remain our property and must be returned at the purchaser's expense.



20:20 31 Dec

Raffreddamento Passivo >

Abbassamento Notturno >

Surgelamento >

Filtro Levigatore >

Lento Chiuso >

